

CV012-2T

Notes:		Date	Name	 <small>THE INFORMATION CONTAINED IN THIS DRAWING IS THE SOLE PROPERTY OF CAVANOVA. ANY REPRODUCTION IN PART OR AS A WHOLE WITHOUT THE WRITTEN PERMISSION OF CAVANOVA IS PROHIBITED.</small>
	Design:	03/12/2018	Diego	
	Checked:		Diego	
	Modified:		Diego	Client:
	Scale: 1:10	Part name: CV012-2T	Top assembly: CV012-2T	Material:
	 Description: Vinoteca para 12botellas	Reference: CV012-2T		
		Count:		
		Pages: 1 OF 4		

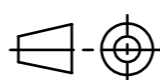
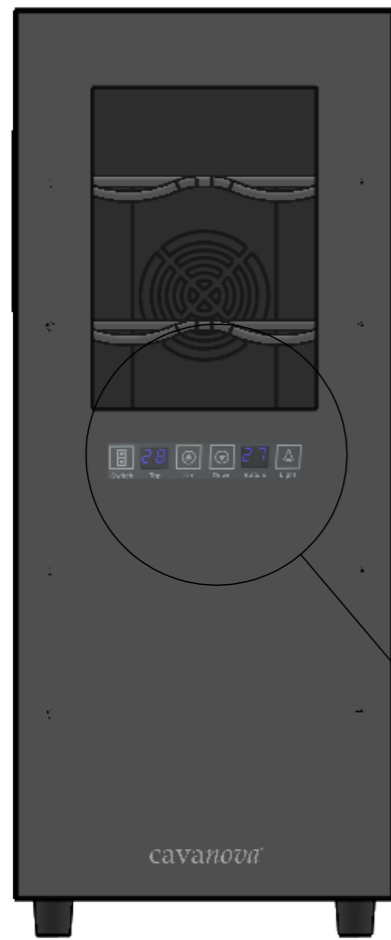

ALZADO

Ventilación

Ventilación

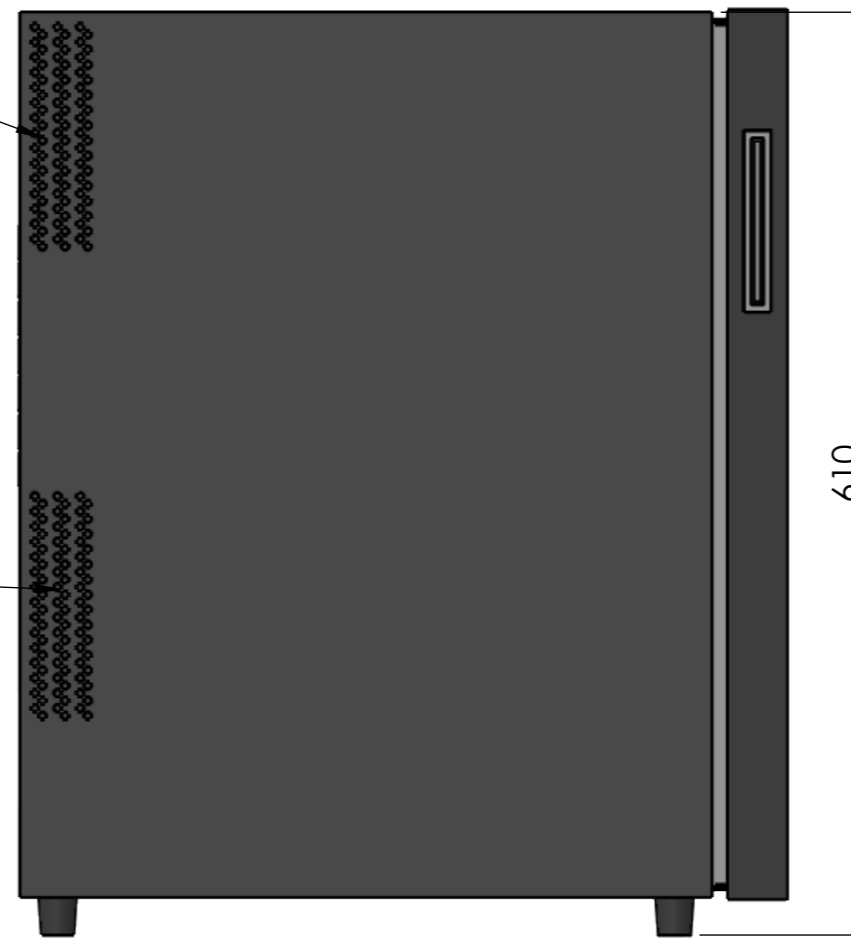

PERFIL

610

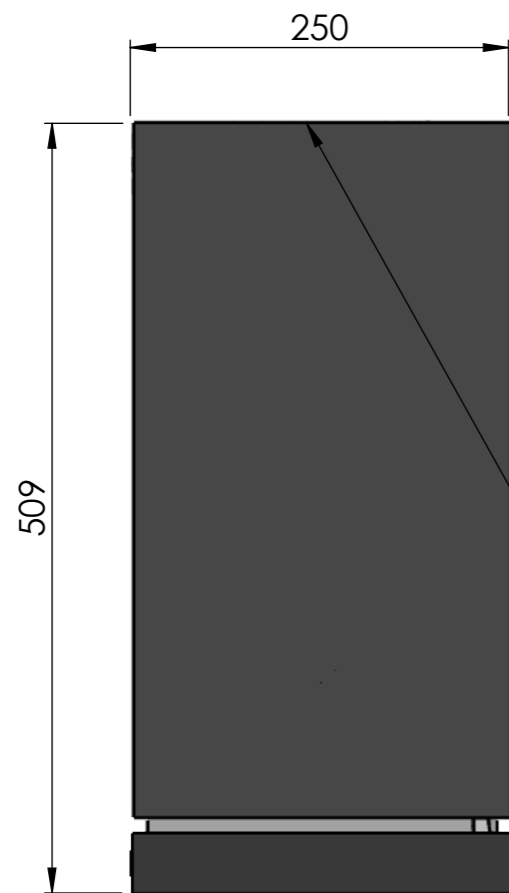

PLANTA

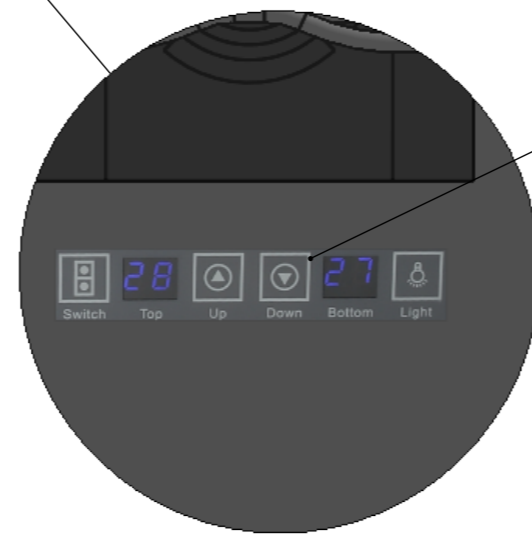

control táctil
temperatura
y luz

Ventilación

DATOS TÉCNICOS	
Volumen	33L
Botellas	12
Frecuencia	50-60hz
Consumo	1(15°C)
Voltaje	220/240-110/115V
Ruido	38db
Humedad interior	>70% RH
Sistema de frío	Termoeléctrico
Rango de temperatura	12-18°C/6-18°C

	Date	Name
Design:	03/12/2018	Diego
Checked:		Diego
Modified:		Diego
Scale: 1:10	Part name: CV012-2T	
Unit:	Top assembly: CV012-2T	

cavanova

THE INFORMATION CONTAINED IN THIS DRAWING IS THE SOLE PROPERTY OF CAVANOVA WINE S.L. IN MÁLAGA, SPAIN. ANY REPRODUCTION IN PART OR AS A WHOLE WITHOUT THE WRITTEN PERMISSION OF CAVANOVA WINE S.L. IS PROHIBITED.

Sign:

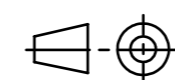

Description:
Vinoteca para 12botellas

Client:
Material:
Reference: CV012-2T
Count:
Pages: 2 OF 4

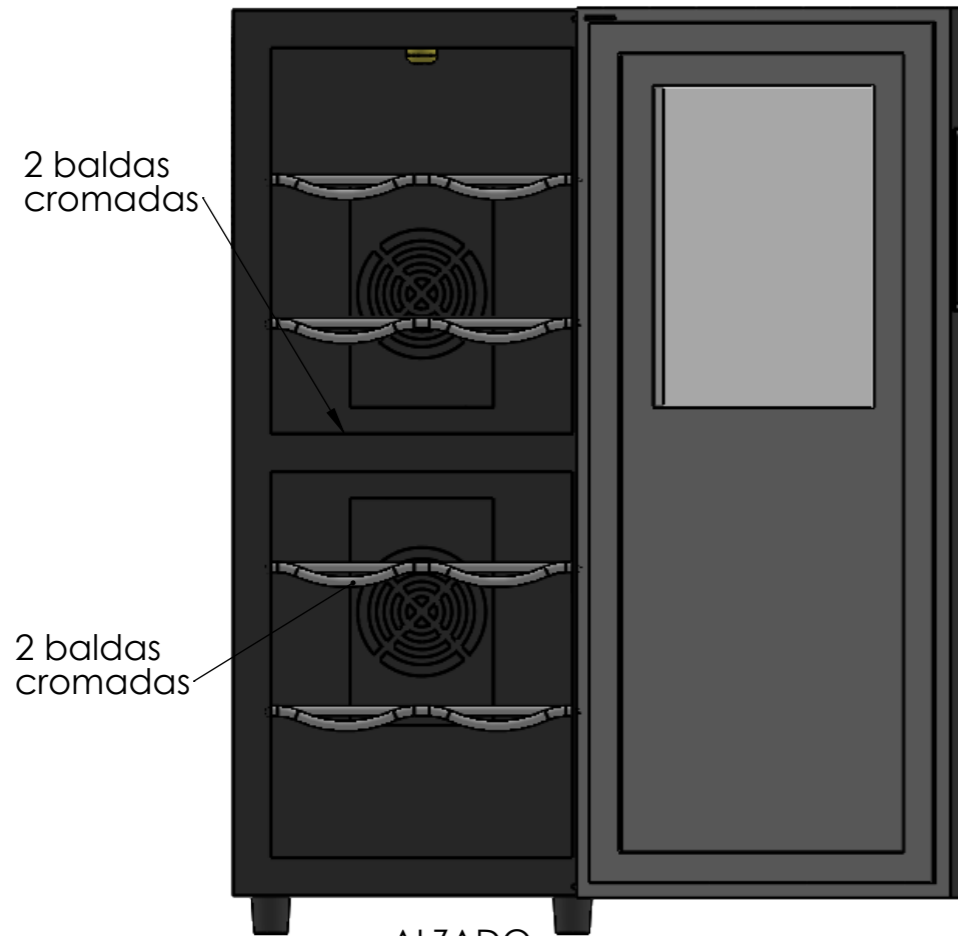

ALZADO

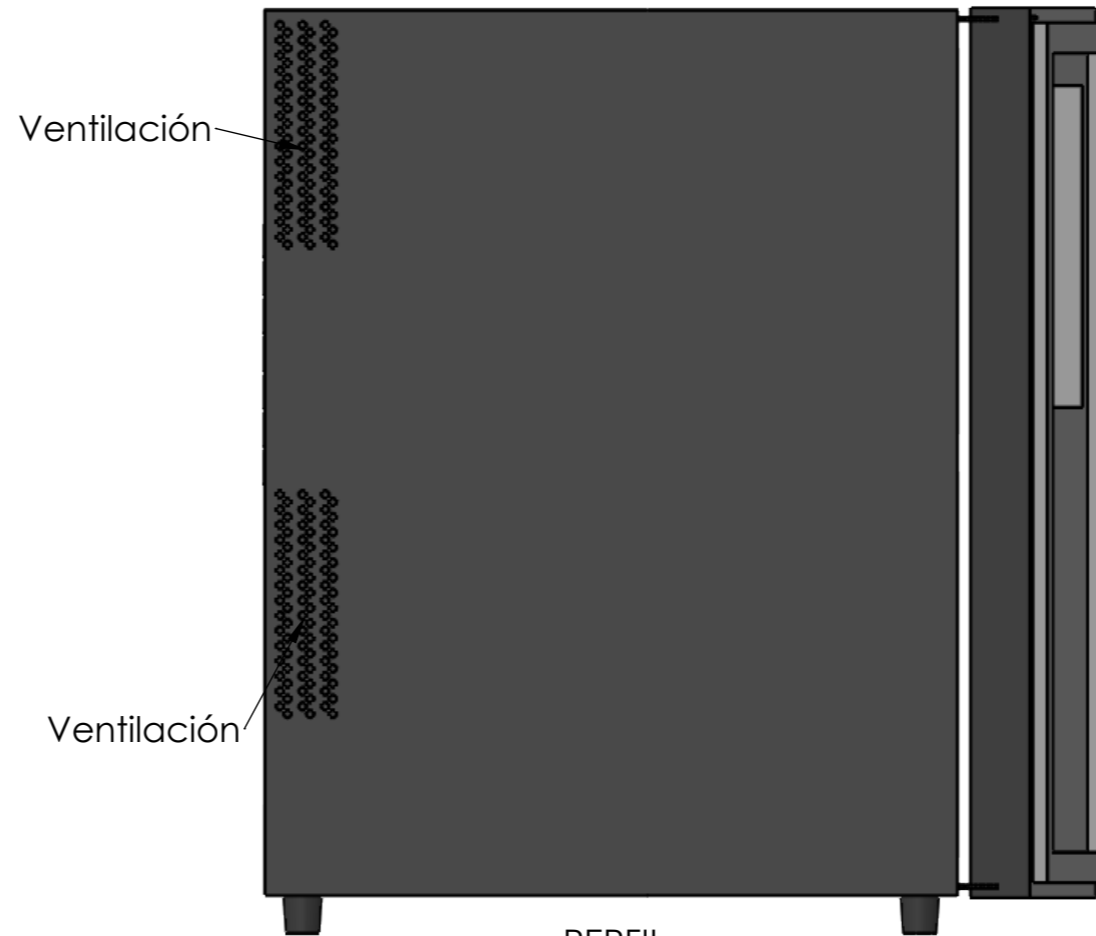

PERFIL

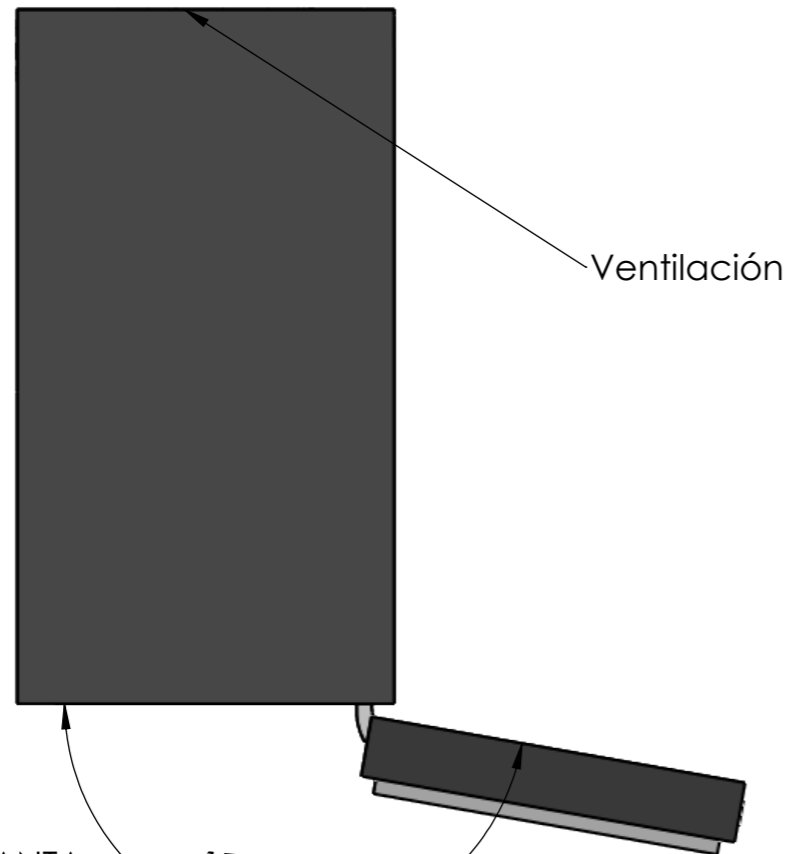
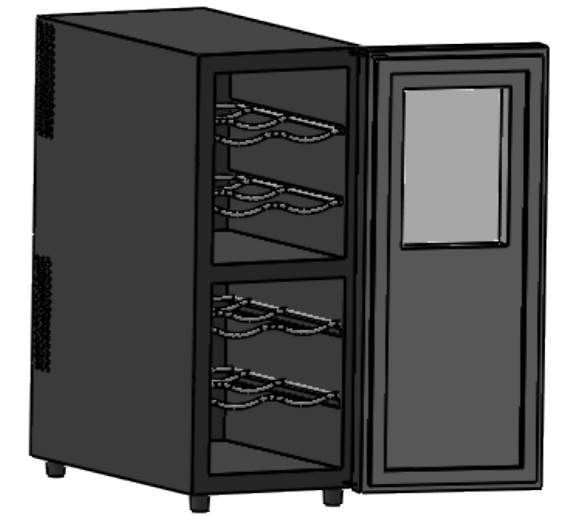

PLANTA

170°max.
apertura

DATOS TÉCNICOS	
Volumen	33L
Botellas	12
Frecuencia	50-60hz
Consumo	1(15°C)
Voltaje	220/240-110/115V
Ruido	38db
Humedad interior	>70% RH
Sistema de frío	Termoeléctrico
Rango de temperatura	12-18°C

	Date	Name
Design:	03/12/2018	Diego
Checked:		Diego
Modified:		Diego
Scale: 1:10	Part name: CV012-2T	
Unit:	Top assembly: CV012-2T	

cavanova

THE INFORMATION CONTAINED IN THIS DRAWING IS THE SOLE PROPERTY OF CAVANOVA WINE S.L. IN MÁLAGA, SPAIN. ANY REPRODUCTION IN PART OR AS A WHOLE WITHOUT THE WRITTEN PERMISSION OF CAVANOVA WINE S.L. IS PROHIBITED.

Sign:

	Description:
	Apertura de puerta

Client:
Material:
Reference: CV012-2T
Count:
Pages: 3 OF 4

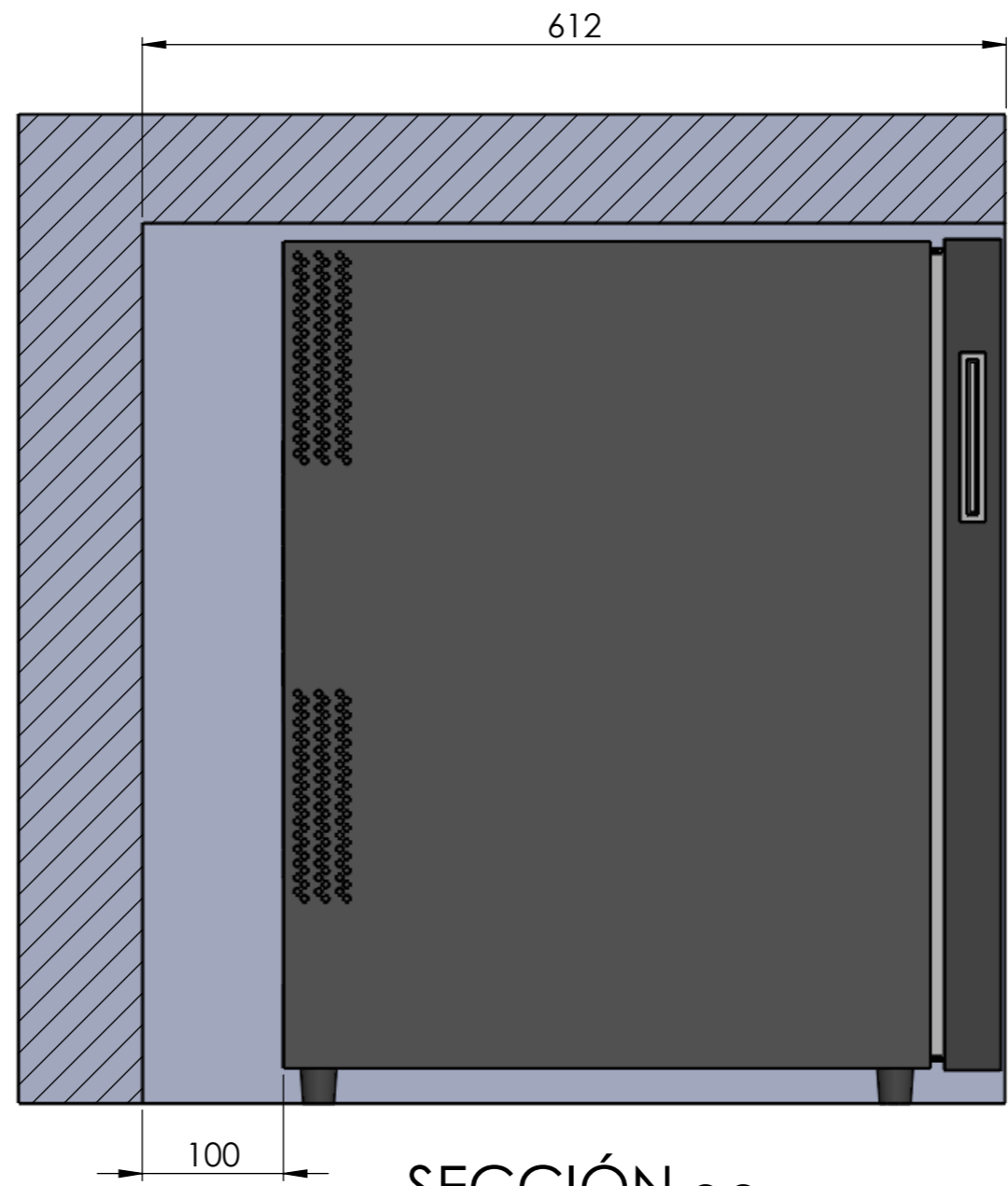
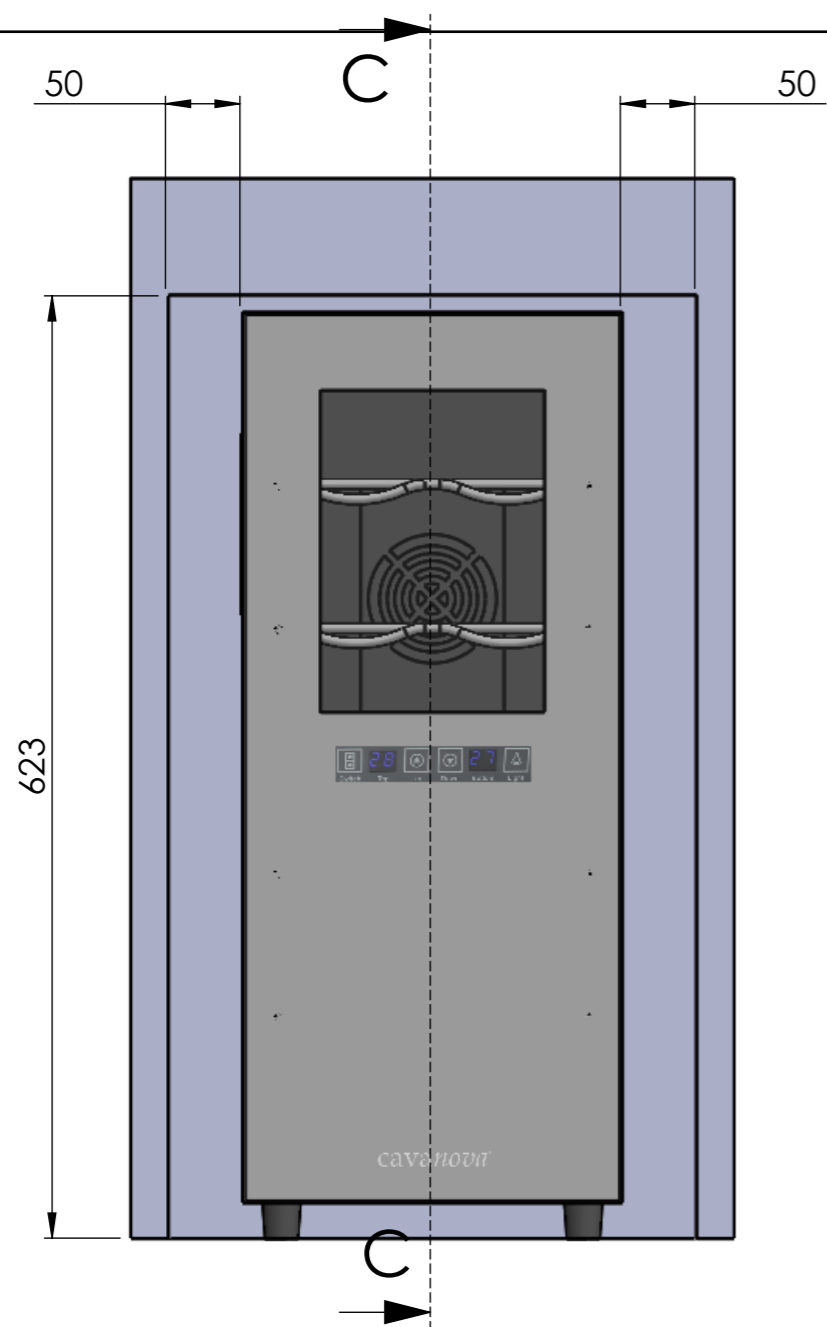

MEDIDAS RECOMENDADAS	
ALTURA	623mm mín
PROFUNDIDAD	100mm mín
ANCHURA	50mm por cada lado

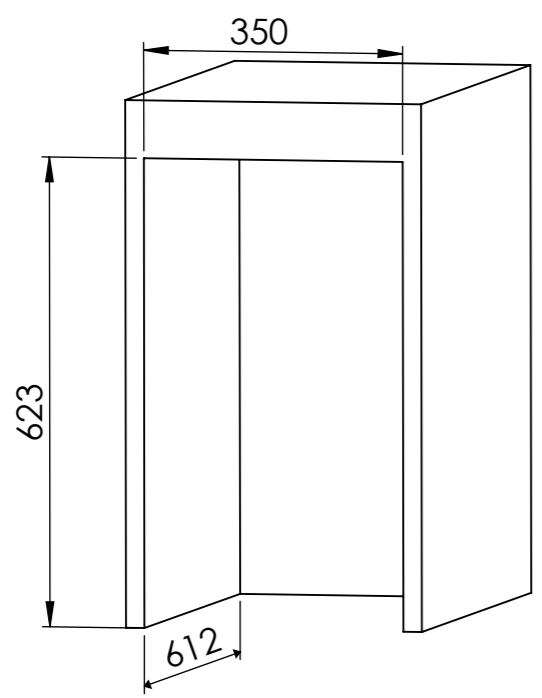

Medidas para hueco

SECCIÓN C-C
ESCALA 1:5

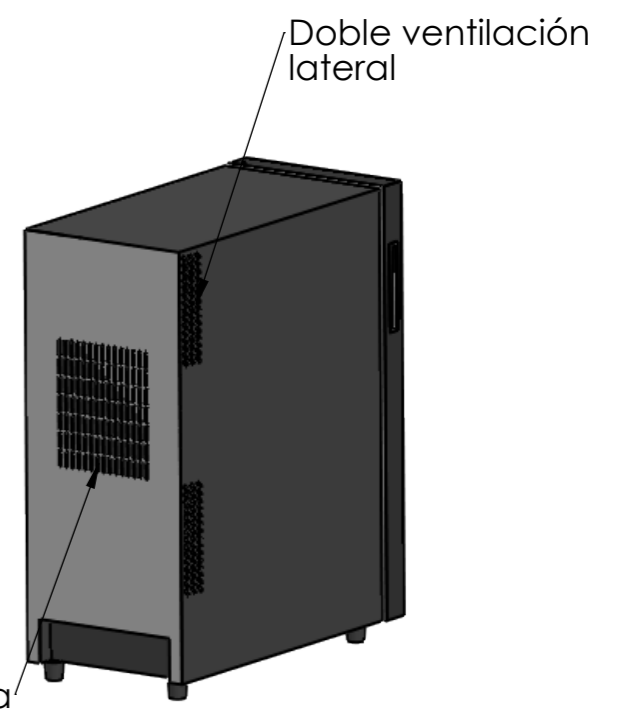

NO OBSTRUIR VENTILACIÓN

Sign:	Date	Name	<p>THE INFORMATION CONTAINED IN THIS DRAWING IS THE SOLE PROPERTY OF CAVANOVA WINE S.L. IN MÁLAGA, SPAIN. ANY REPRODUCTION IN PART OR AS A WHOLE WITHOUT THE WRITTEN PERMISSION OF CAVANOVA WINE S.L. IS PROHIBITED.</p>	Client: Cavanova	
	Design:	09/10/2018			Diego
	Checked:				Diego
	Modified:				Diego
	Scale: 1:10	Part name: CV012-2T-ENTORNO	Top assembly: CV012-2T	Material: Varios	
	Unit: mm	Description: Empotramiento del equipo (built-in)		Reference: CV012-2T-ENTORNO	
				Count:	
				Pages: 4 OF 4	