

CV012M

Notes:		Date	Name	 <small>THE INFORMATION CONTAINED IN THIS DRAWING IS THE SOLE PROPERTY OF CAVANOVA. ANY REPRODUCTION IN PART OR AS A WHOLE WITHOUT THE WRITTEN PERMISSION OF CAVANOVA IS PROHIBITED.</small>
	Design:	03/12/2018	Diego	
	Checked:		Diego	
	Modified:		Diego	Client:
	Scale: 1:10	Part name: CV012M	Top assembly: CV012M	Material:
		Description:	Reference: CV012M	
		Vinoteca para 12botellas	Count:	
			Pages: 1 OF 4	

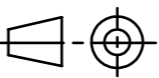
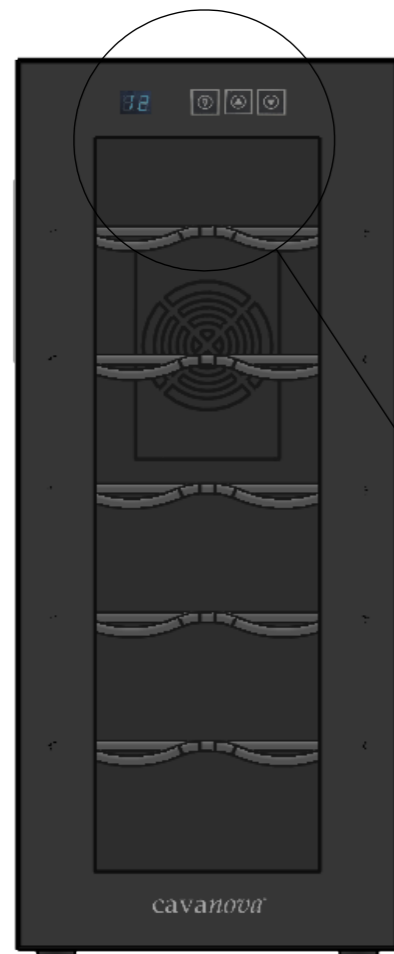

ALZADO

Ventilación

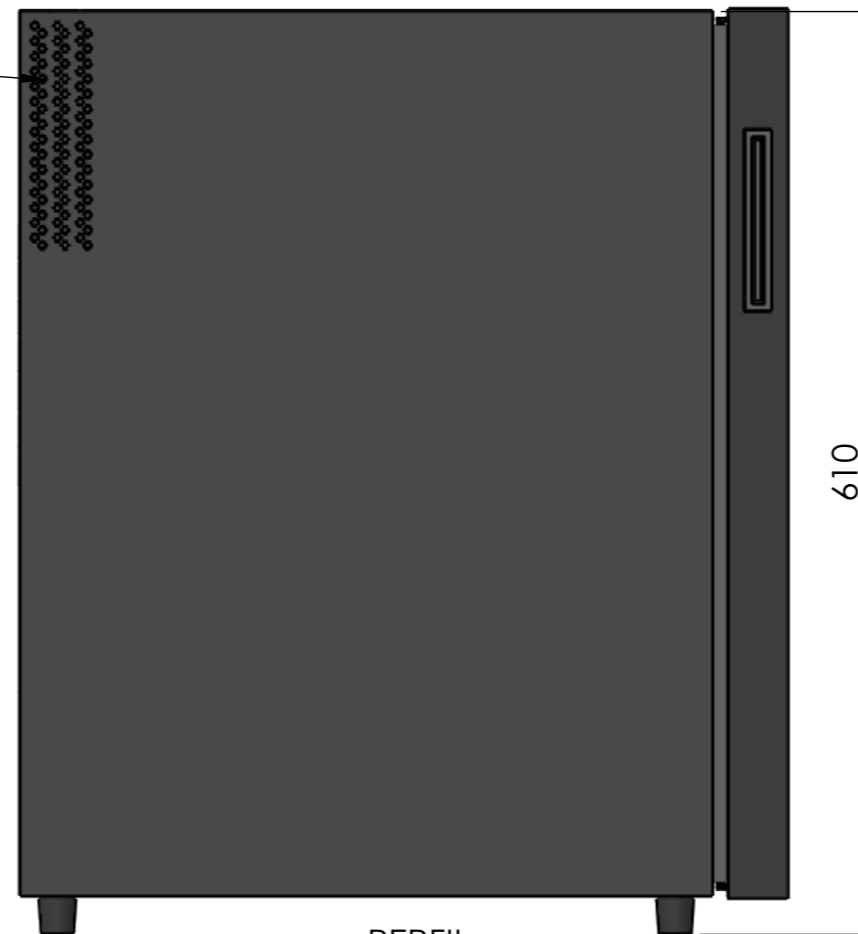

PERFIL

610

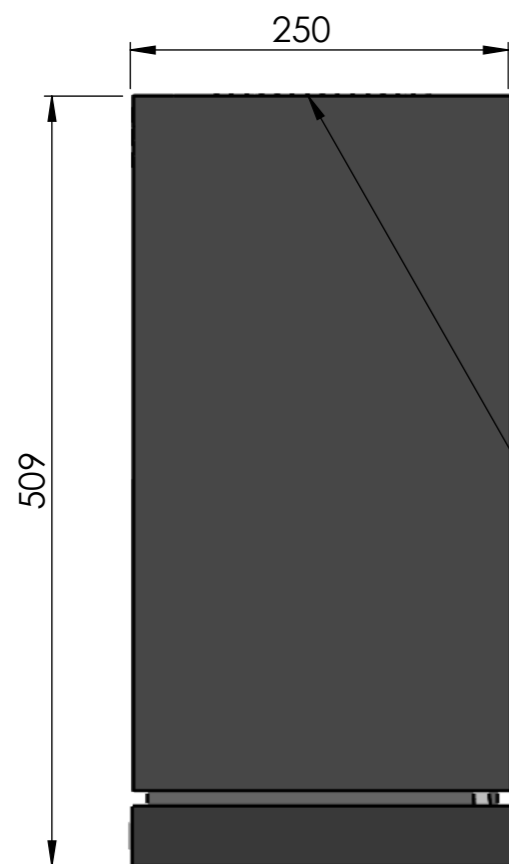

PLANTA

Ventilación

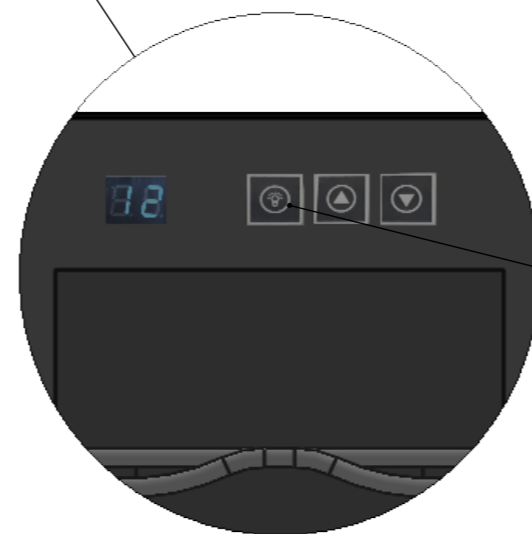

control táctil
temperatura
y luz

DATOS TÉCNICOS	
Volumen	33L
Botellas	12
Frecuencia	50-60hz
Consumo	0.35(15°C)
Voltaje	220/240-110/115V
Ruido	38db
Humedad interior	>70% RH
Sistema de frío	Termoeléctrico
Rango de temperatura	12-18°C

	Date	Name
Design:	03/12/2018	Diego
Checked:		Diego
Modified:		Diego
Scale: 1:10	Part name: CV012M	
Unit:	Top assembly: CV012M	

cavanoa

THE INFORMATION CONTAINED IN THIS DRAWING IS THE SOLE PROPERTY OF CAVANOVA WINE S.L. IN MÁLAGA, SPAIN. ANY REPRODUCTION IN PART OR AS A WHOLE WITHOUT THE WRITTEN PERMISSION OF CAVANOVA WINE S.L. IS PROHIBITED.

Sign:

Unit:

Description:
Vinoteca para 12botellas

Client:
Material:
Reference: CV012M
Count:
Pages: 2 OF 4

6 baldas cromadas

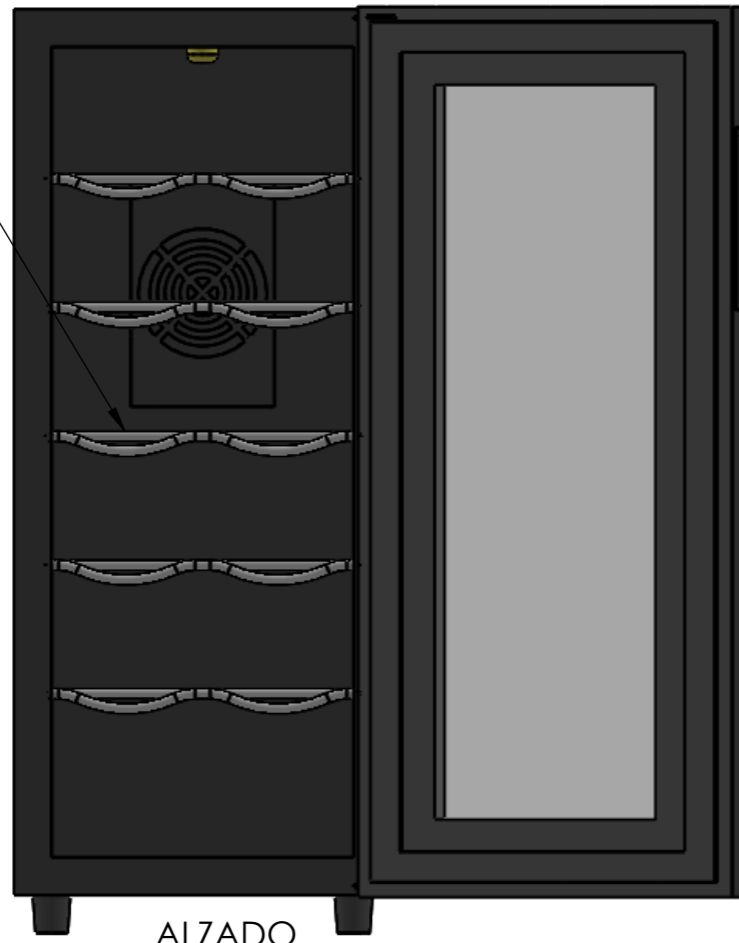

ALZADO

Ventilación

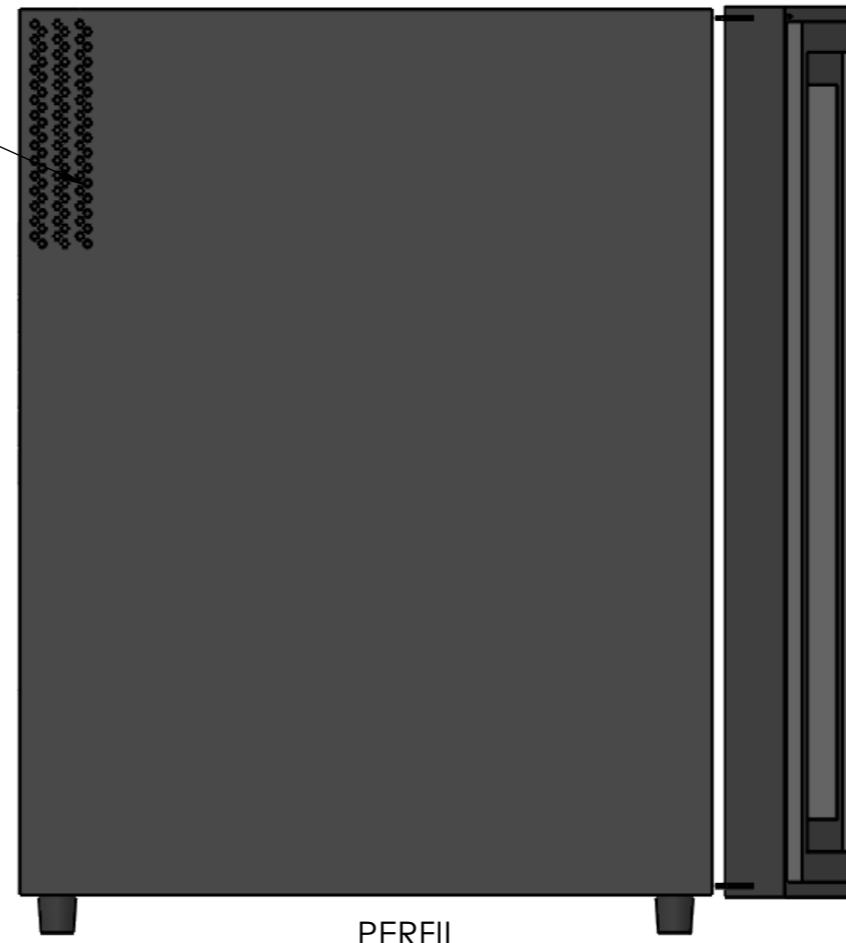

PERFIL

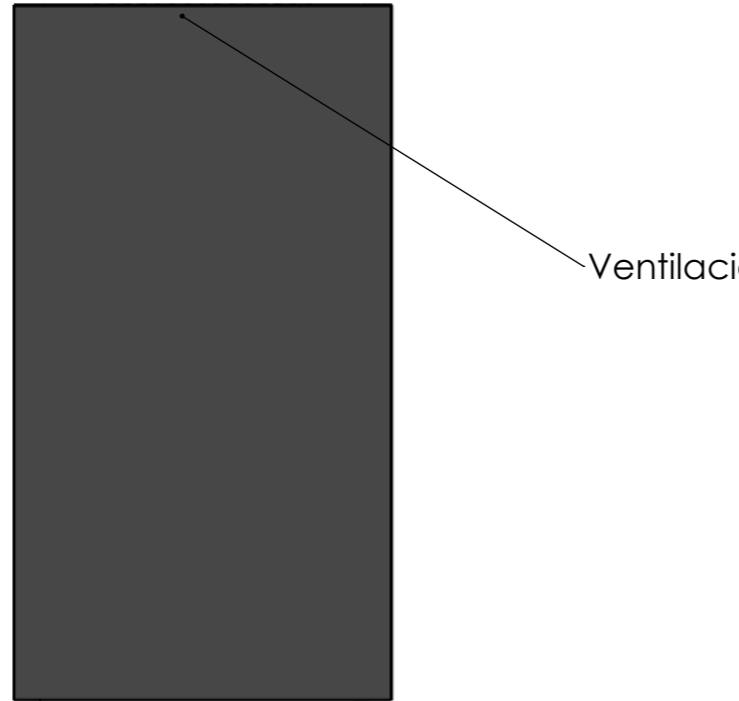
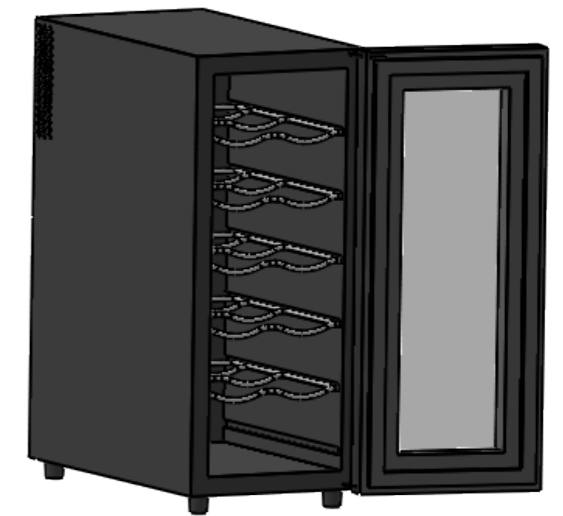

PLANTA

Ventilación

170°max. apertura

DATOS TÉCNICOS

Volumen	33L
Botellas	12
Frecuencia	50-60hz
Consumo	0.35(15°C)
Voltaje	220/240-110/115V
Ruido	38db
Humedad interior	>70% RH
Sistema de frío	Termoeléctrico
Rango de temperatura	12-18°C

	Date	Name
Design:	03/12/2018	Diego
Checked:		Diego
Modified:		Diego
Scale: 1:10	Part name: CV012M	
Unit:	Top assembly: CV012M	

cavanoval

THE INFORMATION CONTAINED IN THIS DRAWING IS THE SOLE PROPERTY OF CAVANOVA WINE S.L. IN MÁLAGA, SPAIN. ANY REPRODUCTION IN PART OR AS A WHOLE WITHOUT THE WRITTEN PERMISSION OF CAVANOVA WINE S.L. IS PROHIBITED.

Sign:

Description:
Apertura de puerta

Client:
Material:
Reference: CV012M
Count:
Pages: 3 OF 4

MEDIDAS RECOMENDADAS	
ALTURA	623mm mín
PROFUNDIDAD	100mm mín
ANCHURA	50mm por cada lado

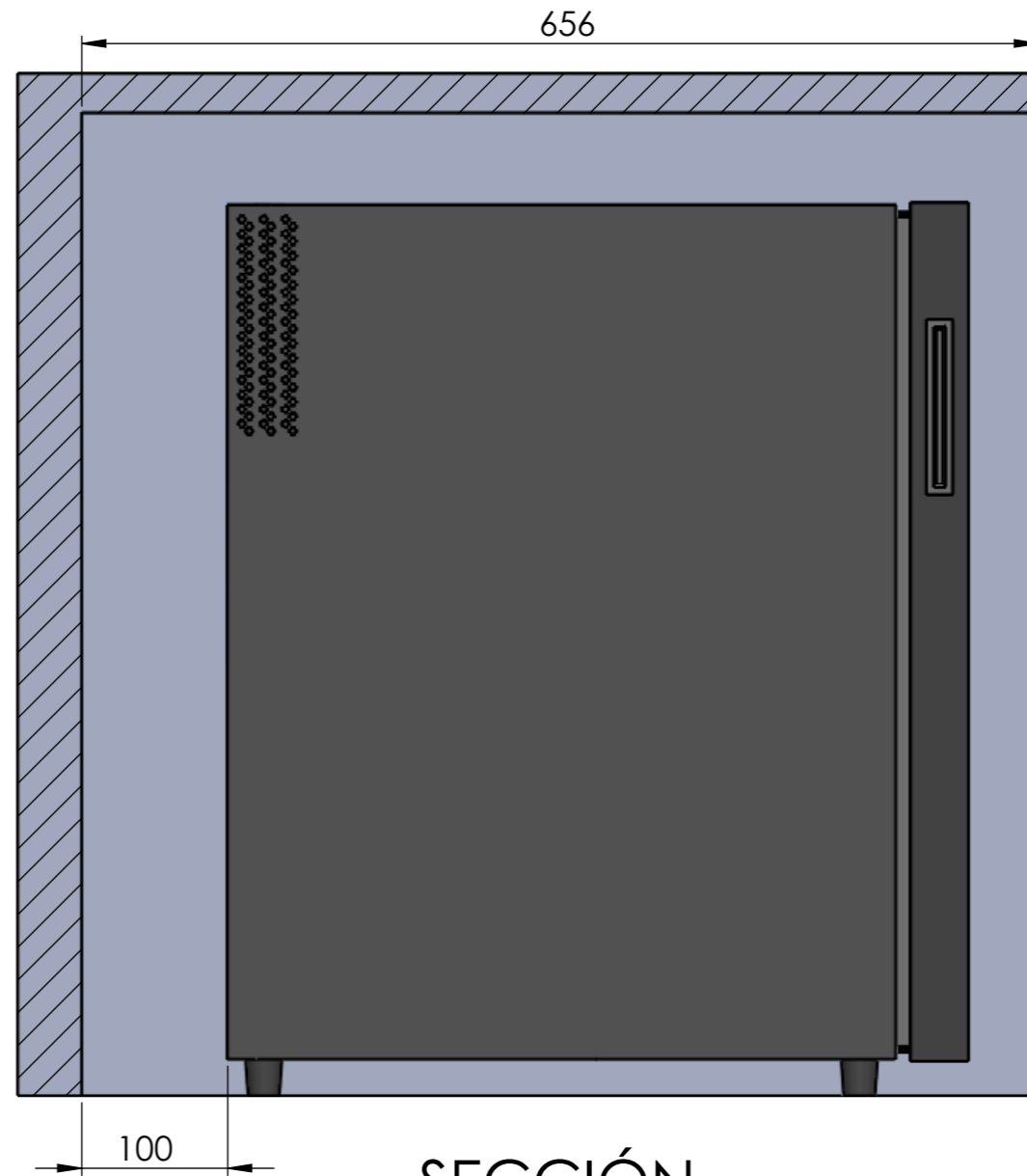
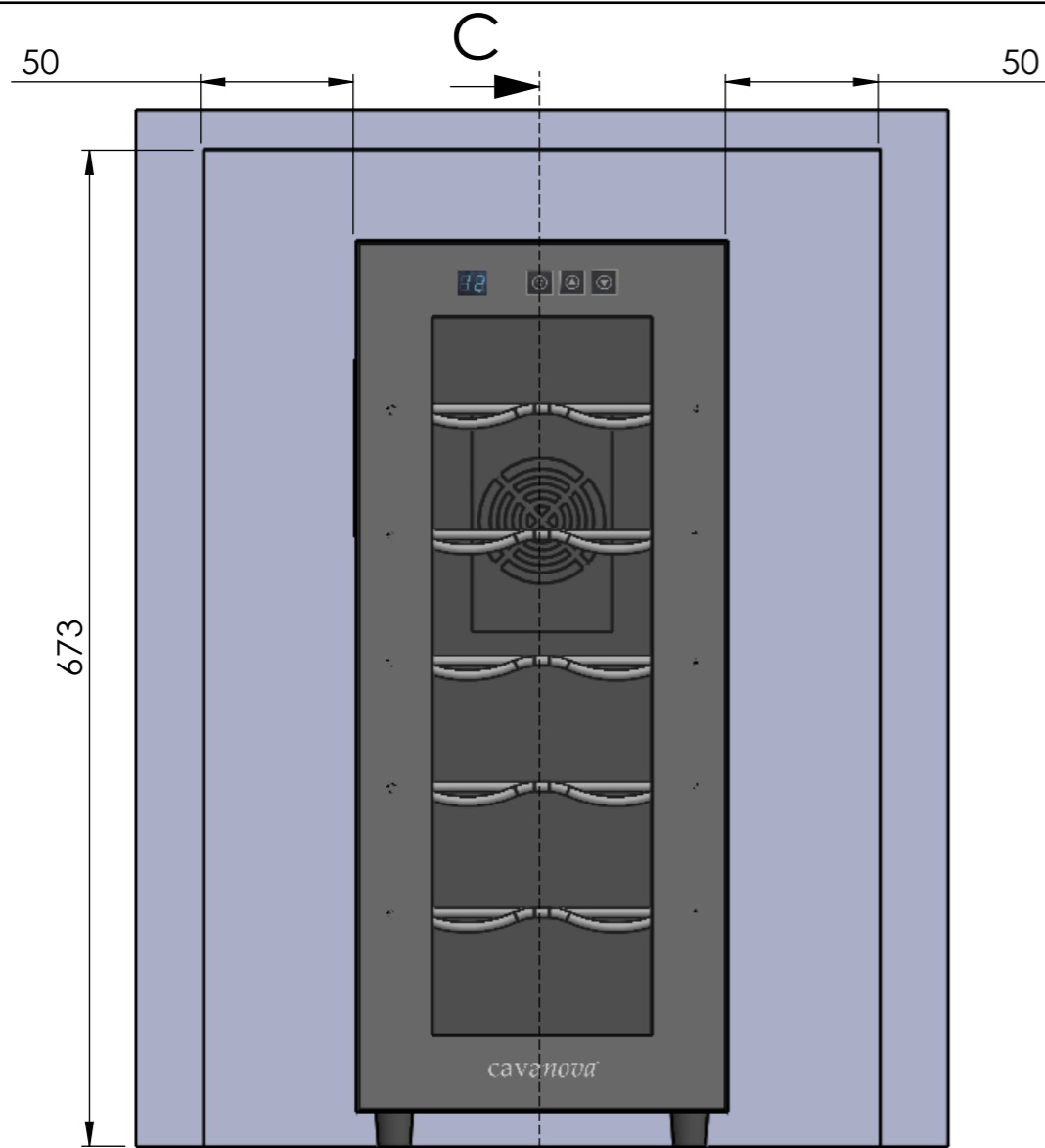

SECCIÓN C-C
ESCALA 1 : 5

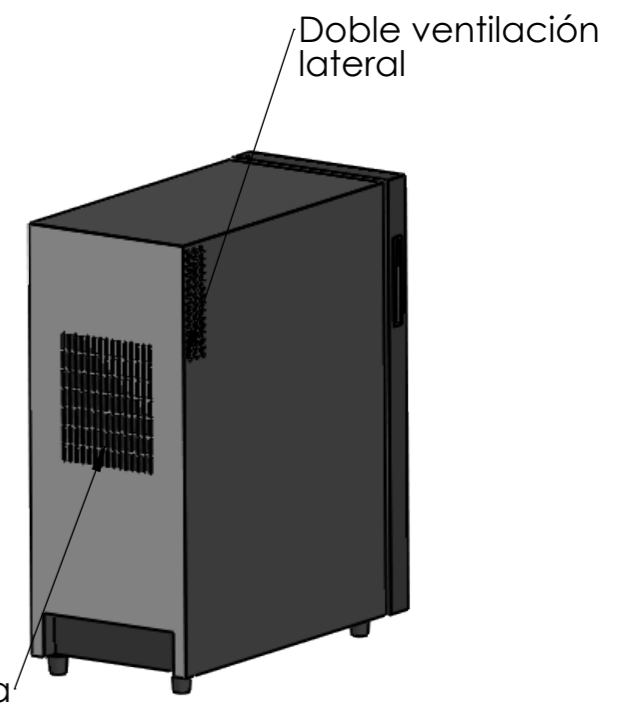

ventilación trasera

NO OBSTRUIR VENTILACIÓN

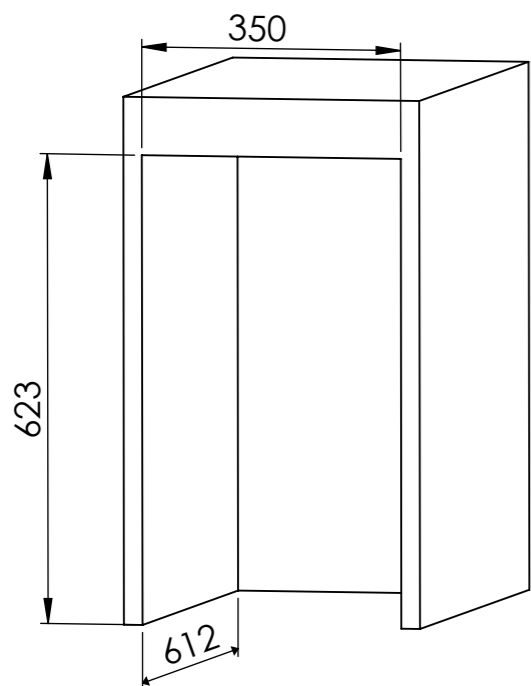

Medidas para hueco

Sign:

Date	Name	cavanova®		
Design: 09/10/2018	Diego	<small>THE INFORMATION CONTAINED IN THIS DRAWING IS THE SOLE PROPERTY OF CAVANOVA WINE S.L. IN MÁLAGA, SPAIN. ANY REPRODUCTION IN PART OR AS A WHOLE WITHOUT THE WRITTEN PERMISSION OF CAVANOVA WINE S.L. IS PROHIBITED.</small>		
Checked:	Diego			
Modified:	Diego			
Scale: 1:10	Part name: CV012M-ENTORNO	Top assembly: CV008ns	Client: Cavanova	
Unit: mm			Material: Varios	
	Description: Empotramiento del equipo (built-in)		Reference: CV012M-ENTORNO	
			Count:	
			Pages: 4 OF 4	