

CV100T

	Date	Name	 <p>THE INFORMATION CONTAINED IN THIS DRAWING IS THE SOLE PROPERTY OF CAVANOVA. ANY REPRODUCTION IN PART OR AS A WHOLE WITHOUT THE WRITTEN PERMISSION OF CAVANOVA IS PROHIBITED.</p>	
Design:	10/12/2018	Diego		
Checked:		Diego		
Modified:		Diego		
Notes:	Scale: 1:20	Part name: CV100T	Top assembly: CV100T	Client: Cavanova
		Description: Capacidad para 100 botellas		Material: Acero pintado
				Reference: CV100T
				Count: 1
				Pages: 1 OF 4

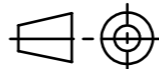

ALZADO

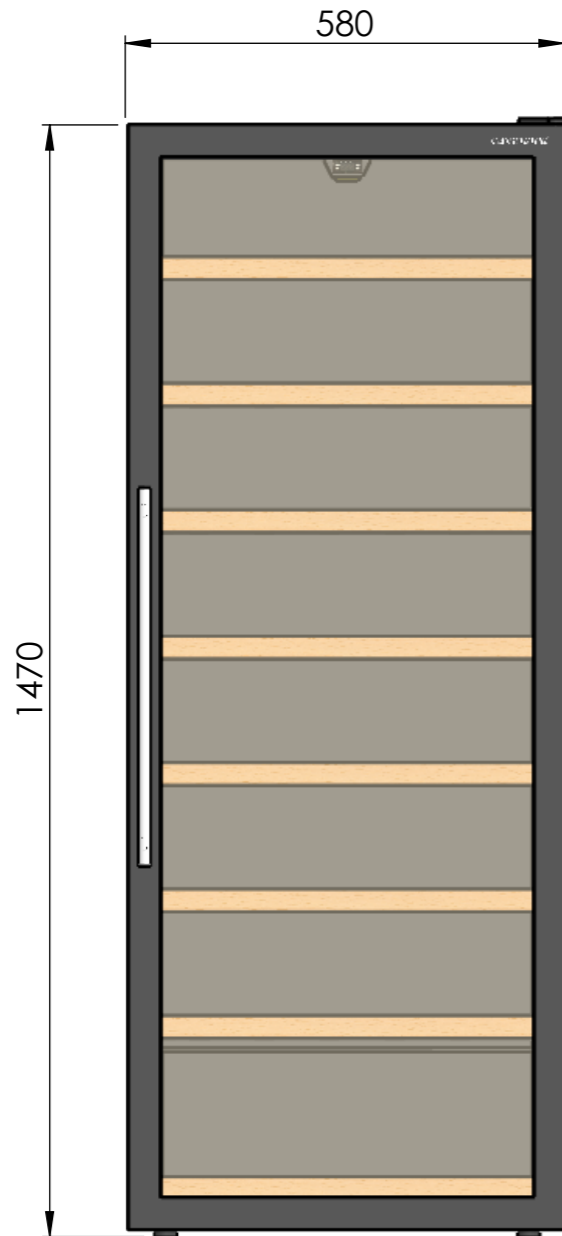
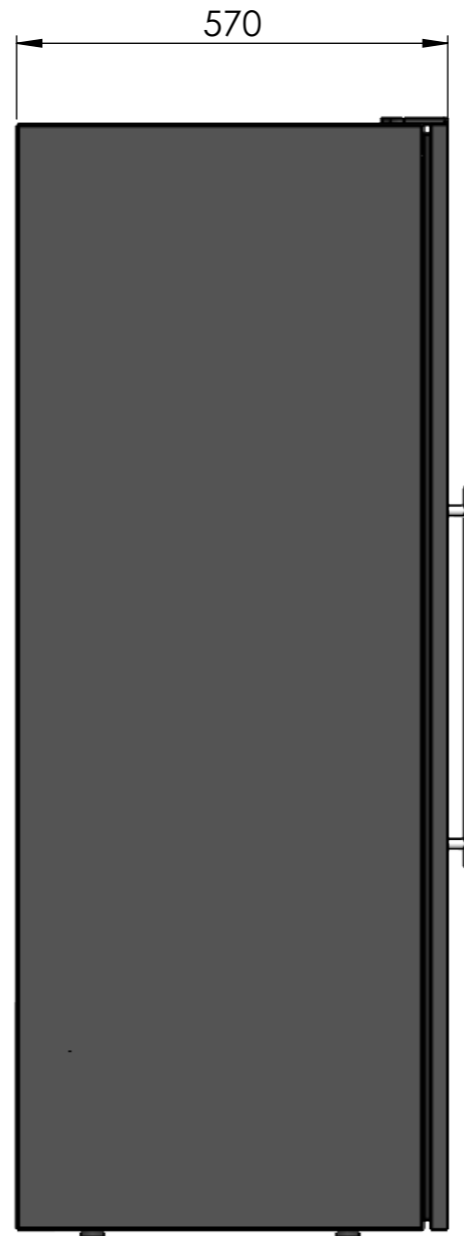

PERFIL

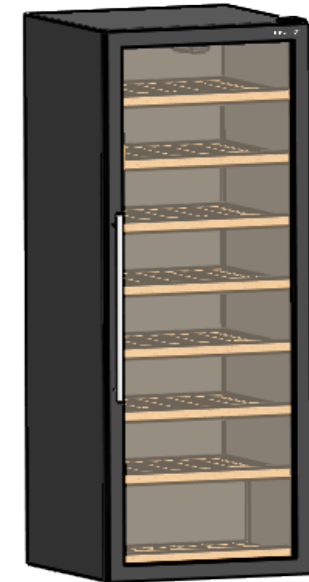

DATOS TÉCNICOS

Volumen	270L
Peso	57kg
Botellas	100
Rango de temperatura	4-18°C
Frecuencia	50-60hz
Consumo	0.86(15°C)
Voltaje	220/240V
Ruido	42db
Refrigerante	R600a
Humedad interior	>70%RH
Sistema de frío	Compresor

	Date	Name
Design:	10/12/2018	Diego
Checked:		Diego
Modified:		Diego

cavanova

THE INFORMATION CONTAINED IN THIS DRAWING IS THE SOLE PROPERTY OF CAVANOVA WINE S.L. IN MÁLAGA, SPAIN. ANY REPRODUCTION IN PART OR AS A WHOLE WITHOUT THE WRITTEN PERMISSION OF CAVANOVA WINE S.L. IS PROHIBITED.

Sign:

Scale: 1:20
Unit: mm

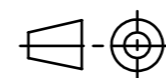

Part name:
CV100T

Top assembly:
CV100T

Description:
Capacidad para 100 botellas

Client: Cavanova
Material: Acero pintado
Reference: CV100T
Count:
Pages: 2 OF 4

8 baldas de madera

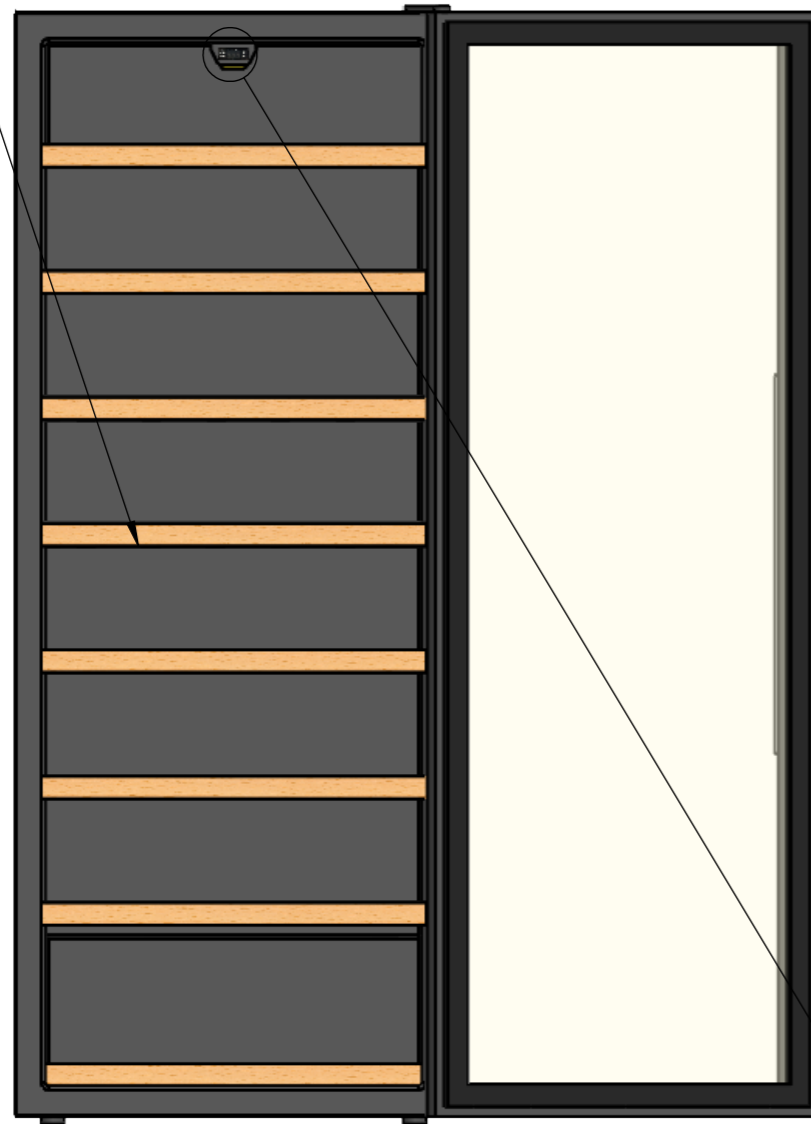

ALZADO

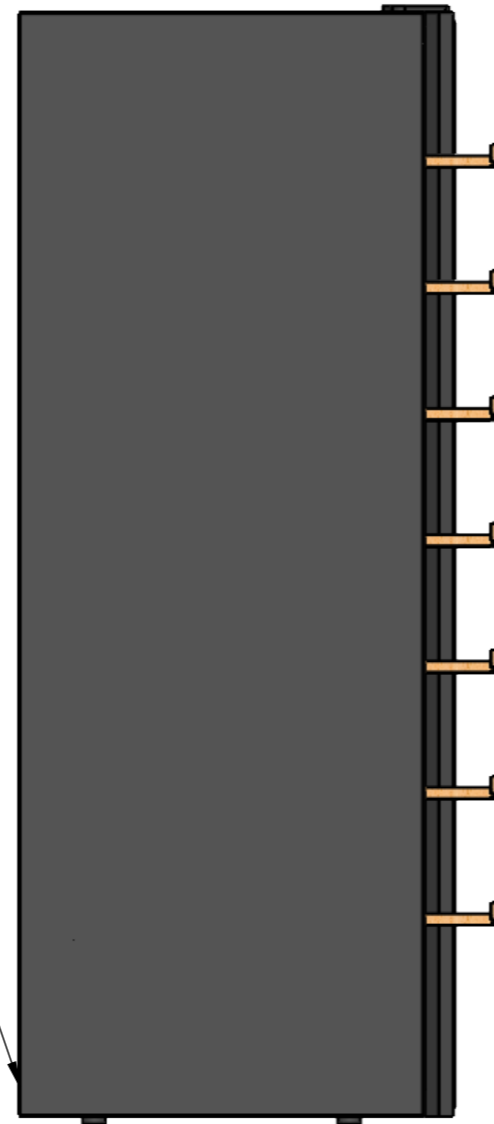

PERFIL

Baldas extraíbles

Compresor

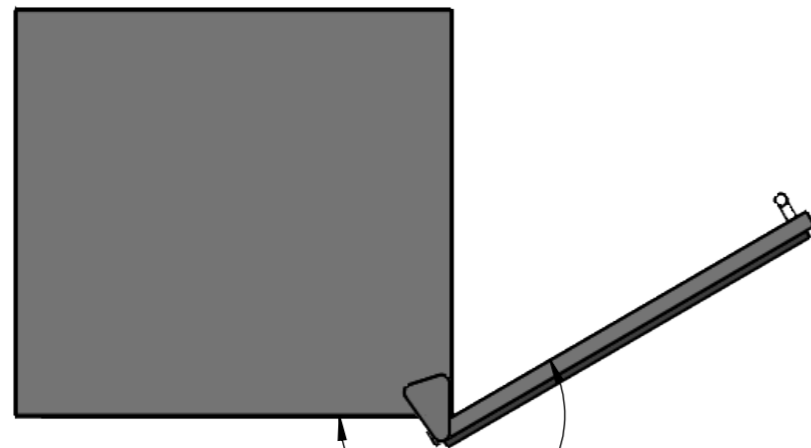
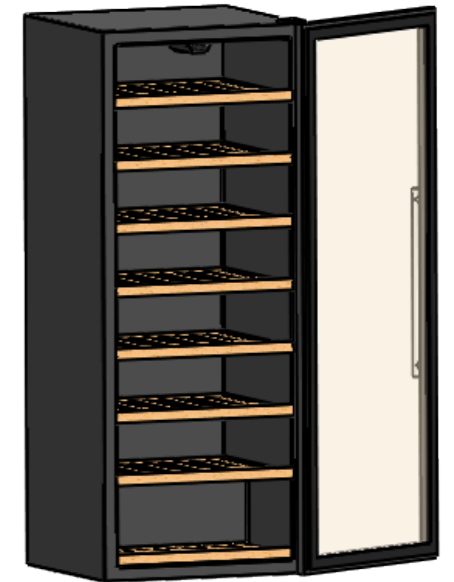

PLANTA

210° max. apertura

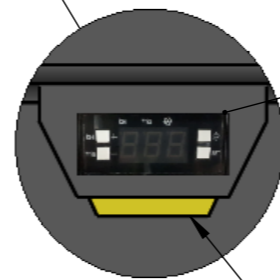

Control de temperatura

Luz

DATOS TÉCNICOS	
Volumen	270L
Peso	57kg
Botellas	100
Rango de temperatura	4-18°C
Frecuencia	50-60hz
Consumo	0.86(15°C)
Voltaje	220/240V
Ruido	42db
Refrigerante	R600a
Humedad interior	>70%RH
Sistema de frío	Compresor

	Date	Name
Design:	10/12/2018	Diego
Checked:		Diego
Modified:		Diego
Scale: 1:20	Part name: CV100T	
Unit: mm	Top assembly: CV100T	

cavanoa

THE INFORMATION CONTAINED IN THIS DRAWING IS THE SOLE PROPERTY OF CAVANOVA WINE S.L. IN MÁLAGA, SPAIN. ANY REPRODUCTION IN PART OR AS A WHOLE WITHOUT THE WRITTEN PERMISSION OF CAVANOVA WINE S.L. IS PROHIBITED.

Sign:

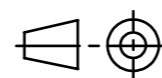

Description:
Capacidad para 100 botellas

Client:	Cavanova
Material:	Acero pintado
Reference:	CV100T
Count:	
Pages:	3 OF 4

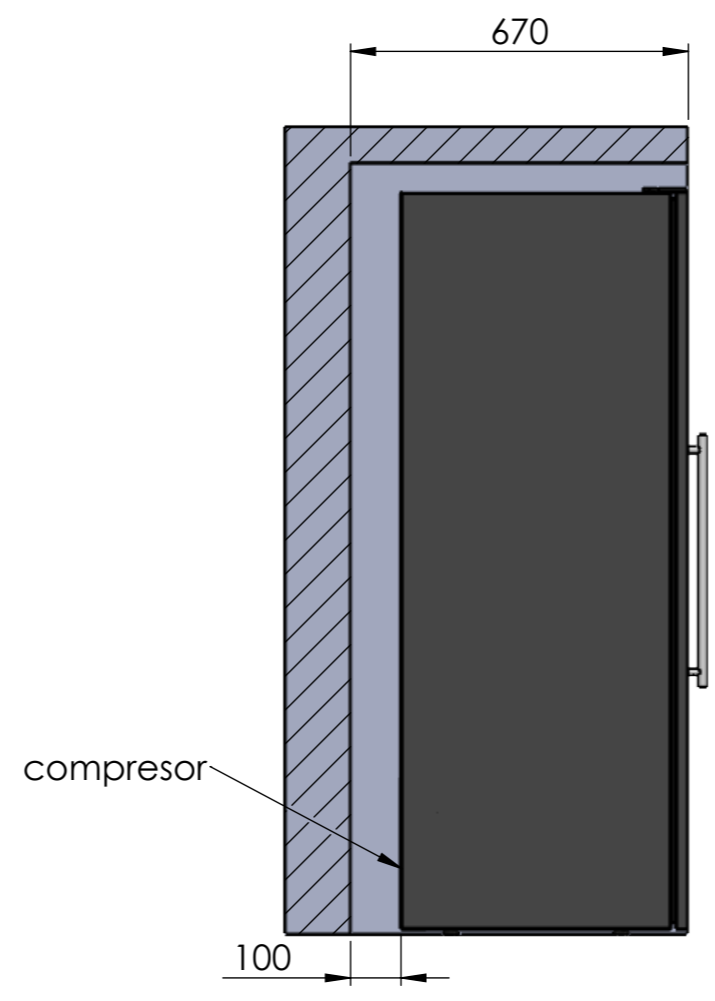
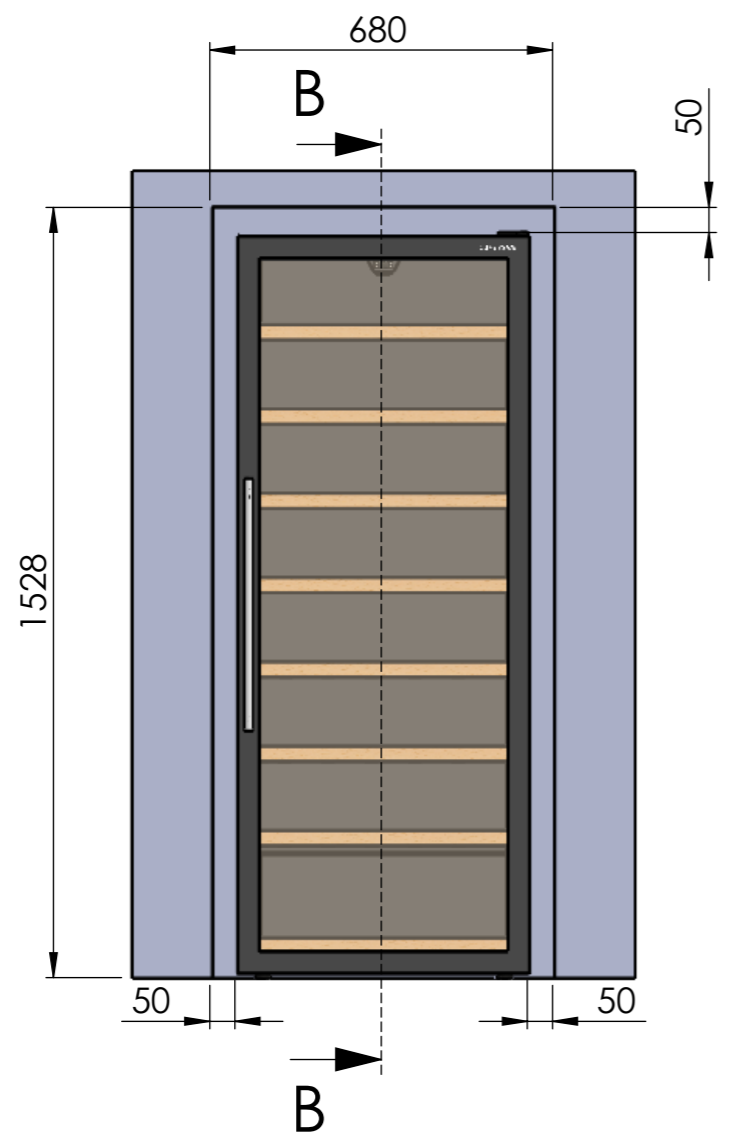

Medidas recomendadas	
Altura	1528mm
Anchura	50mm por cada lado
Profundidad	100mm de espacio

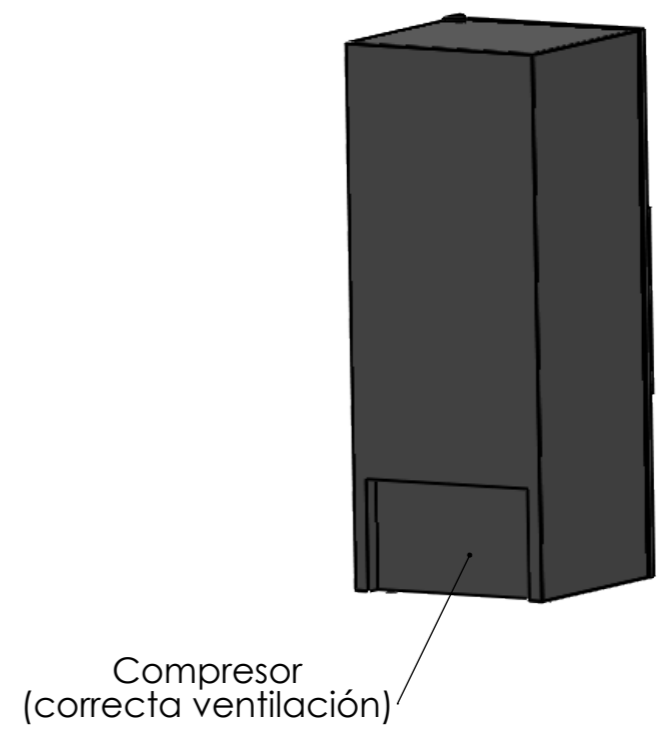
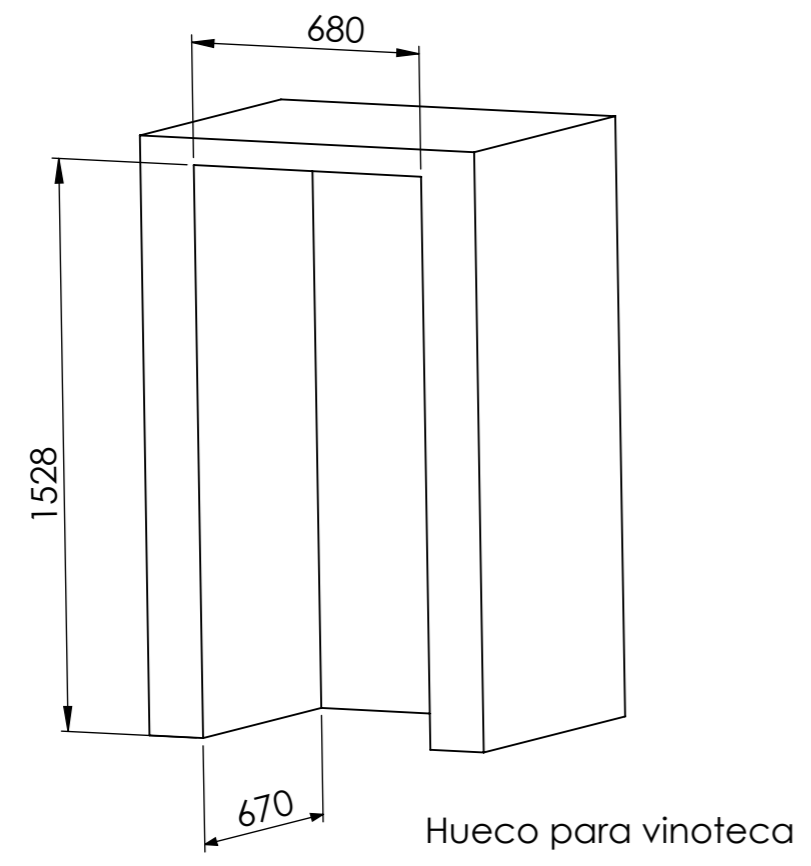

Sign:

Date	Name	cavanova®	
Design: 09/10/2018	Diego	<small>THE INFORMATION CONTAINED IN THIS DRAWING IS THE SOLE PROPERTY OF CAVANOVA WINE S.L. IN MÁLAGA, SPAIN. ANY REPRODUCTION IN PART OR AS A WHOLE WITHOUT THE WRITTEN PERMISSION OF CAVANOVA WINE S.L. IS PROHIBITED.</small>	
Checked:	Diego		
Modified:	Diego		
Scale: 1:20 Unit: mm	Part name: CV100T-ENTORNO	Top assembly: CV120T	Client: Cavanova
	Description: Empotramiento del equipo (built-in)		Material: Varios
			Reference: CV100T-ENTORNO
			Count:
			Pages: 4 OF 4