

CV120DT

	Date	Name	 <p>THE INFORMATION CONTAINED IN THIS DRAWING IS THE SOLE PROPERTY OF CAVANOVA WINE S.L. IN MÁLAGA, SPAIN. ANY REPRODUCTION IN PART OR AS A WHOLE WITHOUT THE WRITTEN PERMISSION OF CAVANOVA WINE S.L. IS PROHIBITED.</p>	
Design:	09/10/2018	Diego		
Checked:		Diego		
Modified:		Diego		
Sign:	Scale: 1:20	Part name: CV120DT	Top assembly: CV120DT	Client: Cavanova
	Unit: mm			Material: Acero inoxidable pintado
		Description:		Reference: cv120dt
		Cava de dos temperaturas independientes 102 botellas		Count:
				Pages: 1 OF 4

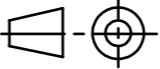

No obstruir ventilación

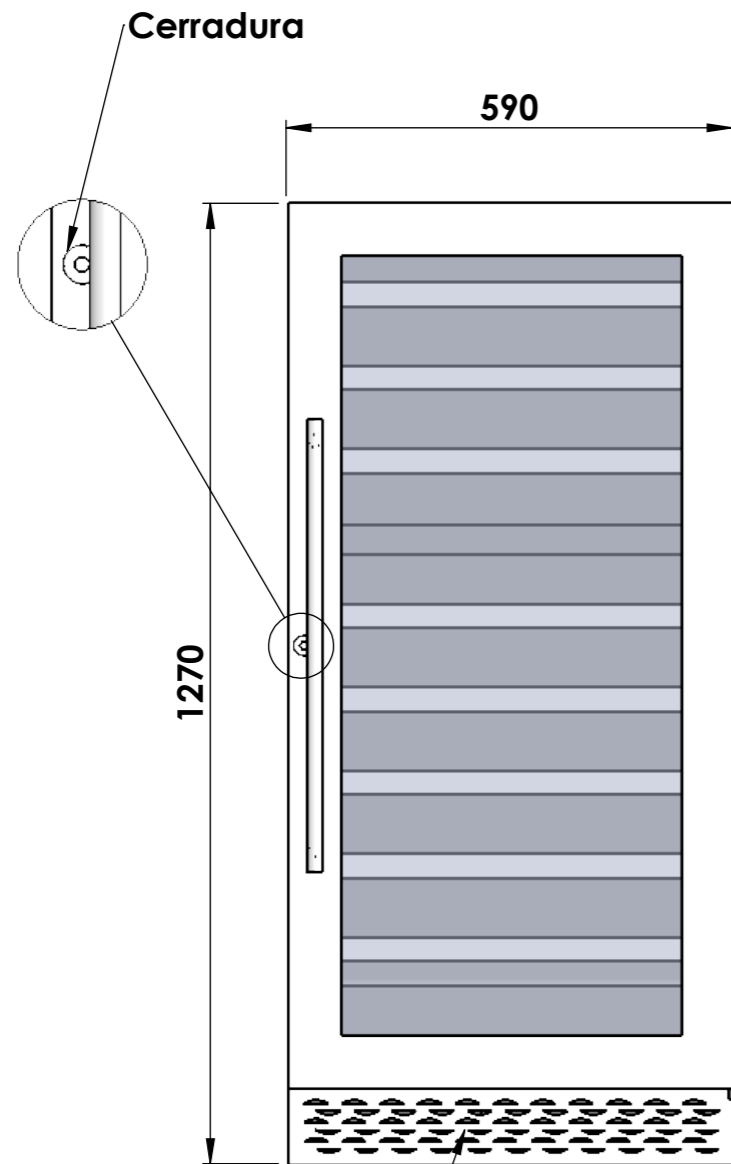
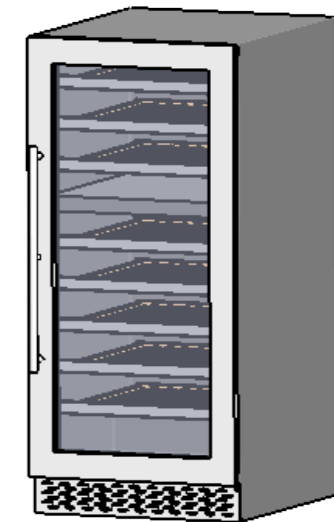
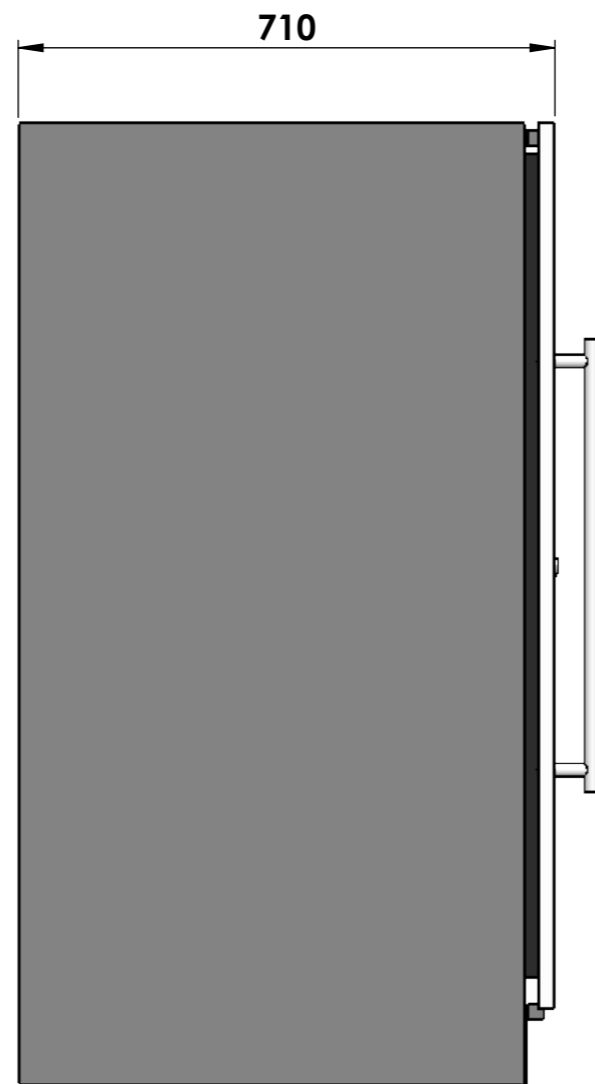

DATOS TÉCNICOS

Volumen	267L
Frecuencia	50-60Hz
Botellas	102
Rango de temperatura	5-20°C (zonas individuales o comunes)
Consumo	1(12°C)kw/d
Voltaje	220/240-110/115V
Ruido	43db
Refrigerante	R600a
Humedad interior	>70%RH
Sistema de frío	Compresor

	Date	Name
Design:	09/10/2018	Diego
Checked:		Diego
Modified:		Diego

cavanova

THE INFORMATION CONTAINED IN THIS DRAWING IS THE SOLE PROPERTY OF CAVANOVA WINE S.L. IN MÁLAGA, SPAIN. ANY REPRODUCTION IN PART OR AS A WHOLE WITHOUT THE WRITTEN PERMISSION OF CAVANOVA WINE S.L. IS PROHIBITED.

Sign:

Scale: 1:20	Part name: CV120DT
Unit: mm	
Description: Cava de dos temperaturas independientes 102 botellas	

Top assembly: CV120DT	Client: Cavanova
	Material: Acero inoxidable pintado
	Reference: cv120DT
	Count:
	Pages: 2 OF 4

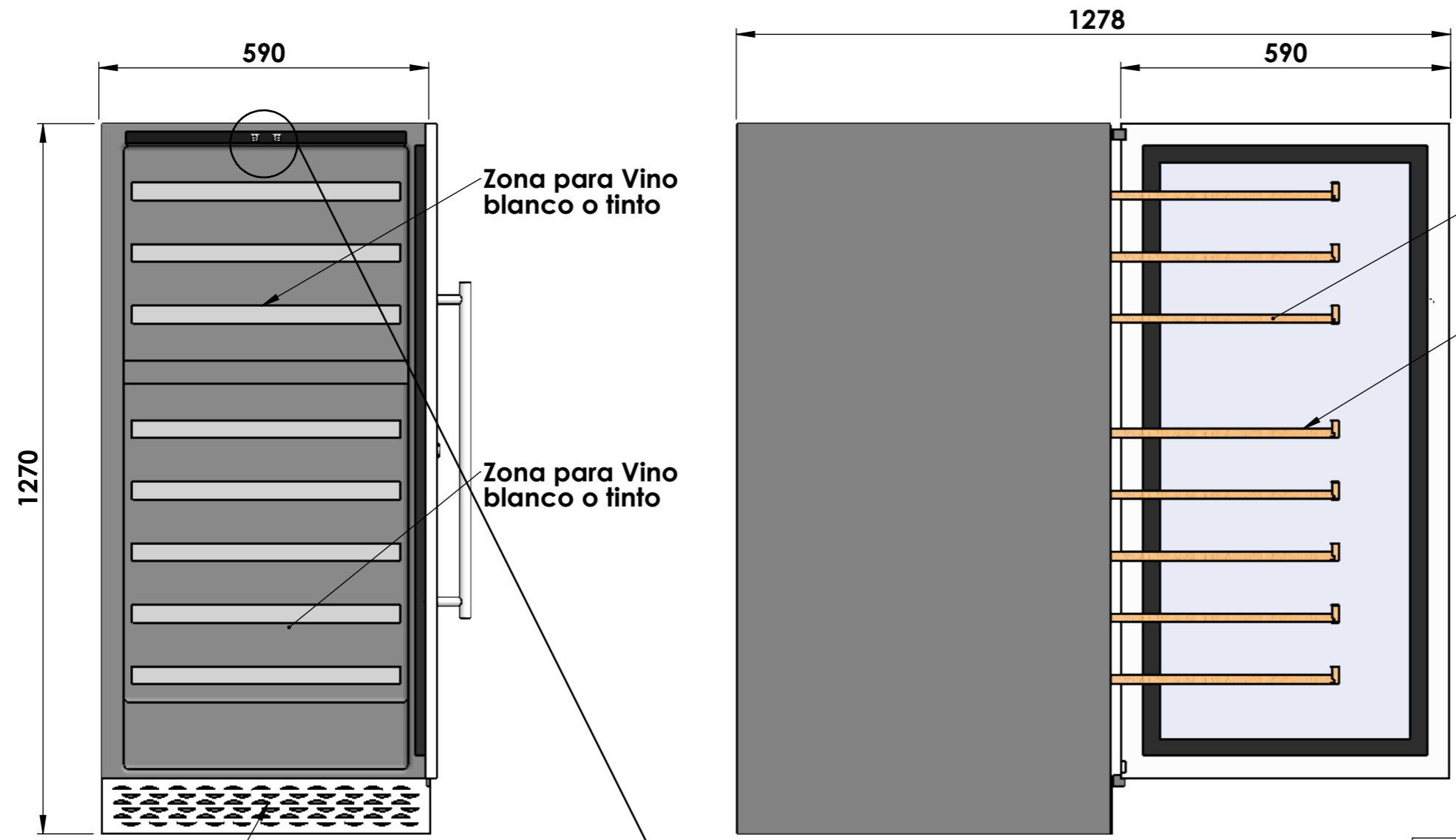

No obstruir ventilación

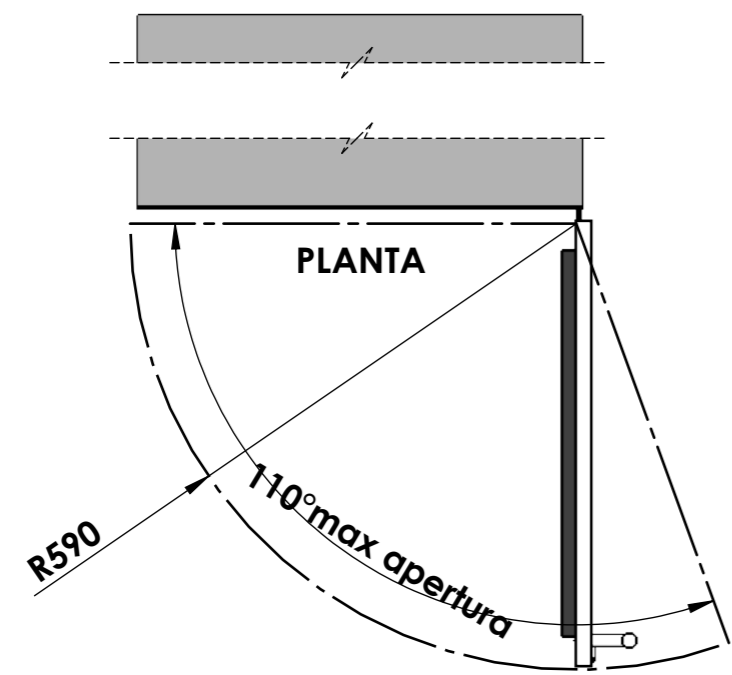

PERFIL



Control de temperatura

Baldas extraibles
8 Baldas de madera acadao con inoxidable

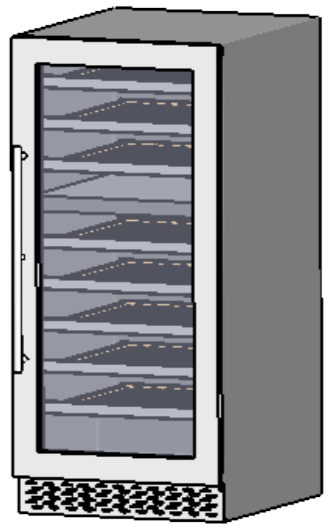

DATOS TÉCNICOS	
Volumen	267L
Frecuencia	50-60Hz
Botellas	102
Rango de temperatura	5-20°C (zonas individuales o comunes)
Consumo	1(12°C)kw/d
Voltaje	220/240-110/115V
Ruido	43db
Refrigerante	R600a
Humedad interior	>70%RH
Sistema de frío	Compresor

	Date	Name
Design:	09/10/2018	Diego
Checked:		Diego
Modified:		Diego

cavanoa

THE INFORMATION CONTAINED IN THIS DRAWING IS THE SOLE PROPERTY OF CAVANOVA WINE S.L. IN MÁLAGA, SPAIN. ANY REPRODUCTION IN PART OR AS A WHOLE WITHOUT THE WRITTEN PERMISSION OF CAVANOVA WINE S.L. IS PROHIBITED.

Sign:

Scale: 1:20
Unit: mm

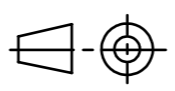

Part name: CV120DT
Top assembly: CV120DT

Description: Dimensiones con la puerta abierta

Client: Cavanoa
Material: Varios
Reference: cv120dt
Count:
Pages: 3 OF 4

MEDIDAS RECOMENDADAS	
ALTURA	1280mm
ANCHURA	605mm
PROFUNDIDAD	730mm

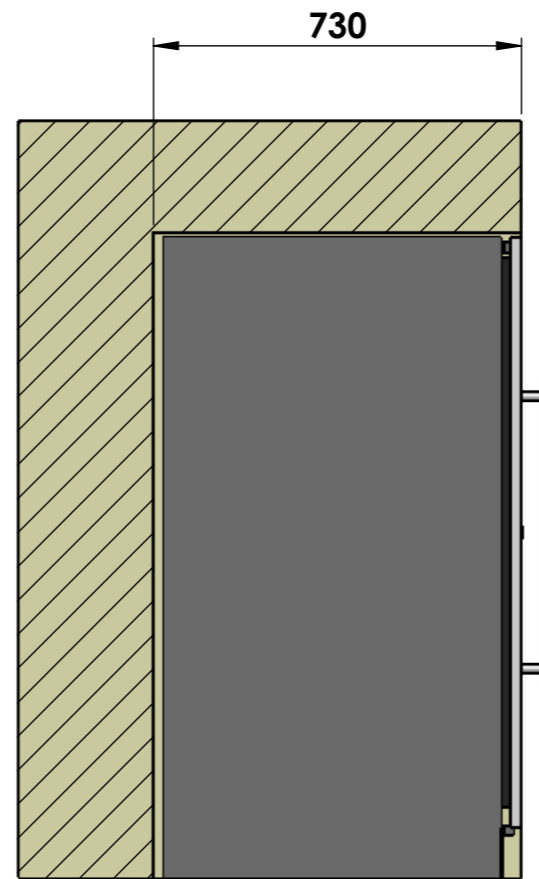
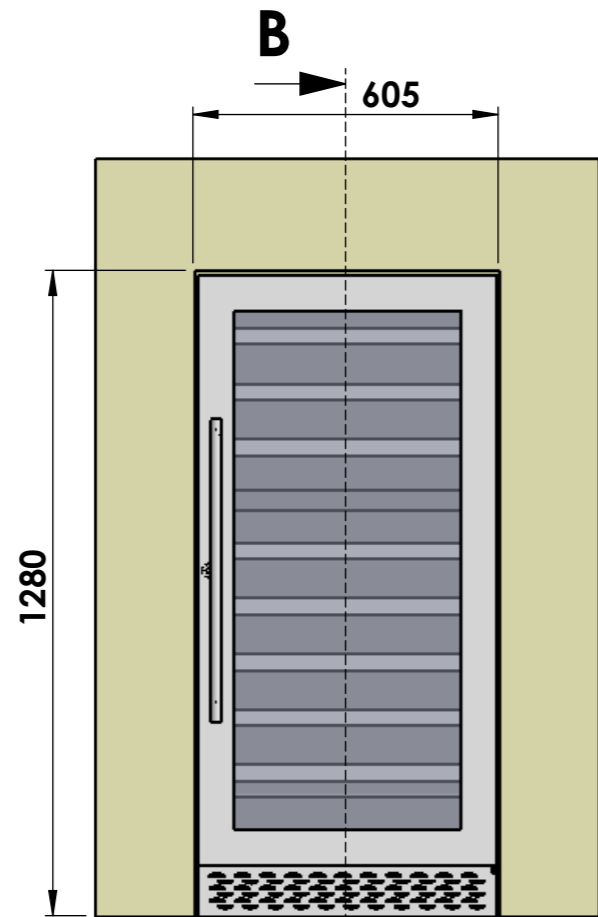

SECCIÓN B-B
ESCALA 1 : 15

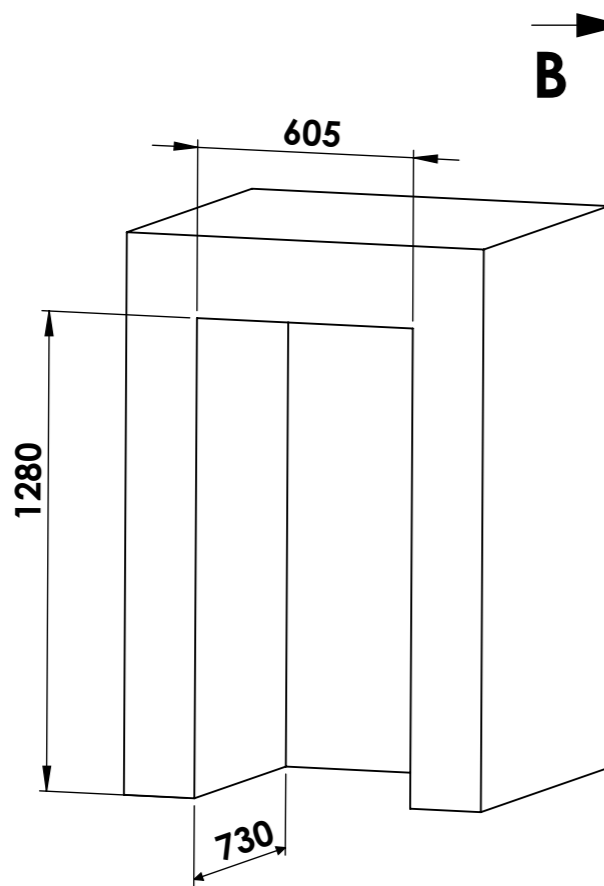
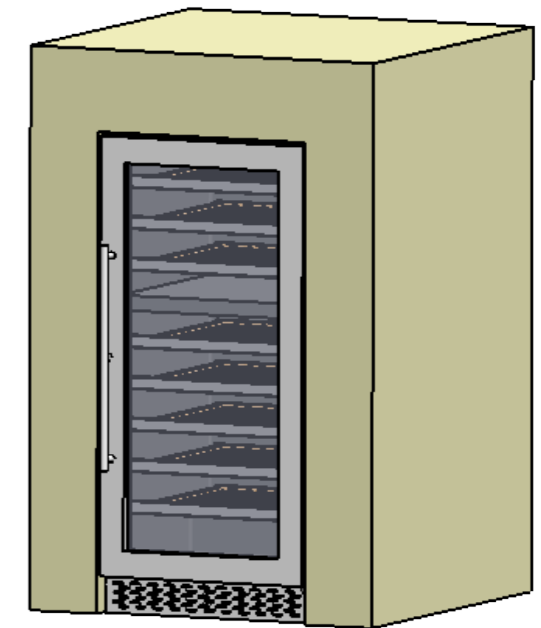

Hueco para integrar vinoteca en mueble

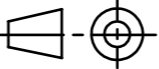
	Date	Name	 <small>THE INFORMATION CONTAINED IN THIS DRAWING IS THE SOLE PROPERTY OF CAVANOVA WINE S.L. IN MÁLAGA, SPAIN. ANY REPRODUCTION IN PART OR AS A WHOLE WITHOUT THE WRITTEN PERMISSION OF CAVANOVA WINE S.L. IS PROHIBITED.</small>	
Design:	09/10/2018	Diego		
Checked:		Diego		
Modified:		Diego		
Scale: 1:20	Part name:	Top assembly:	Client:	Cavanova
Unit: mm	CV120DT-ENTORNO	CV120DT	Material: Varios	
	Description:		Reference: CV120DT-ENTORNO	Count:
	Empotramiento del equipo (built-in)		Pages: 4 OF 4	

Sign: