

CV046DT

cavano[®]

THE INFORMATION CONTAINED IN THIS DRAWING IS THE SOLE PROPERTY OF CAVANOVA WINE S.L. IN MÁLAGA, SPAIN. ANY REPRODUCTION IN PART OR AS A WHOLE WITHOUT THE WRITTEN PERMISSION OF CAVANOVA WINE S.L. IS PROHIBITED.

	Date	Name		
Design:	09/10/2018	Diego		
Checked:		Diego		
Modified:		Diego		
Sign:	Scale: 1:10	Part name: CV046DT	Top assembly: CV046T	Client: Cavanova
	Unit: mm			Material: Acero inoxidable pintado
	Description:			Reference: CV046DT
	Vinoteca para 46 botellas			Count:
				Pages: 1 OF 4

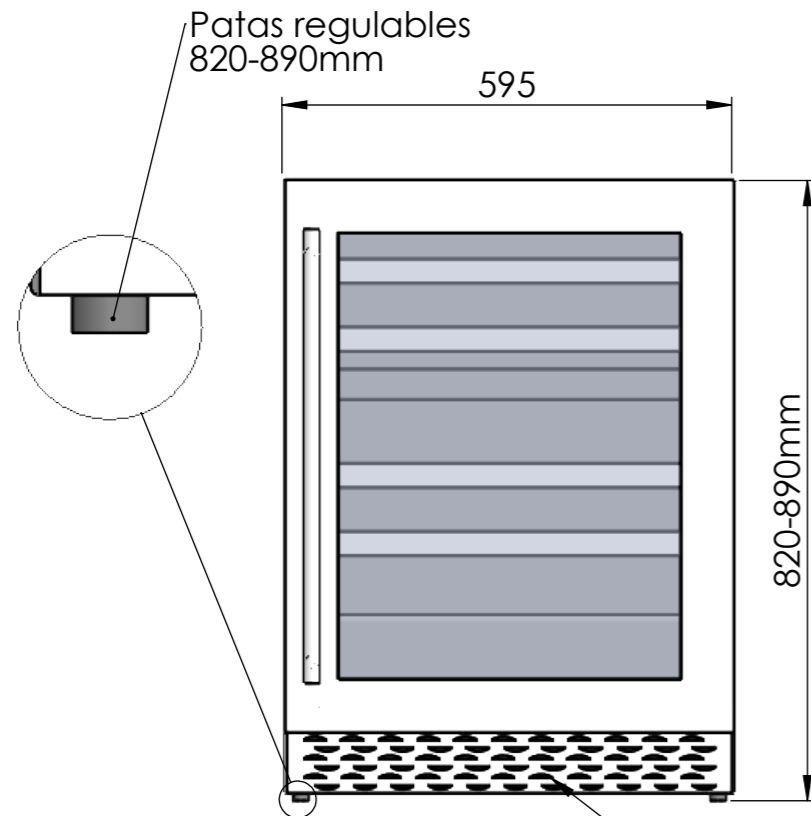

ALZADO

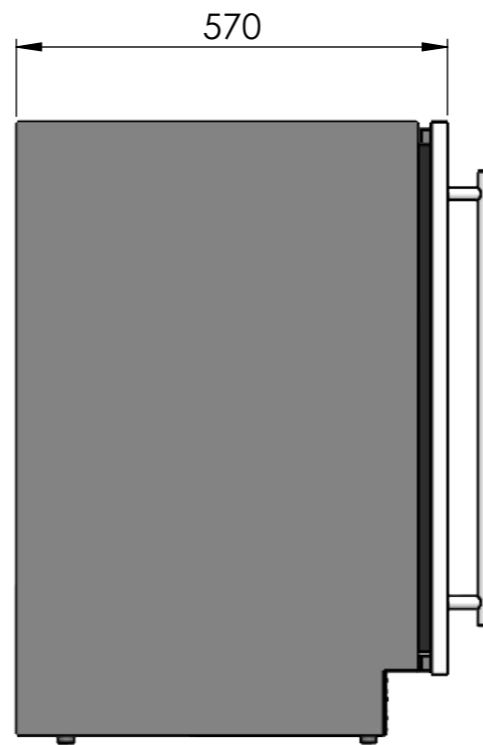

PERFIL

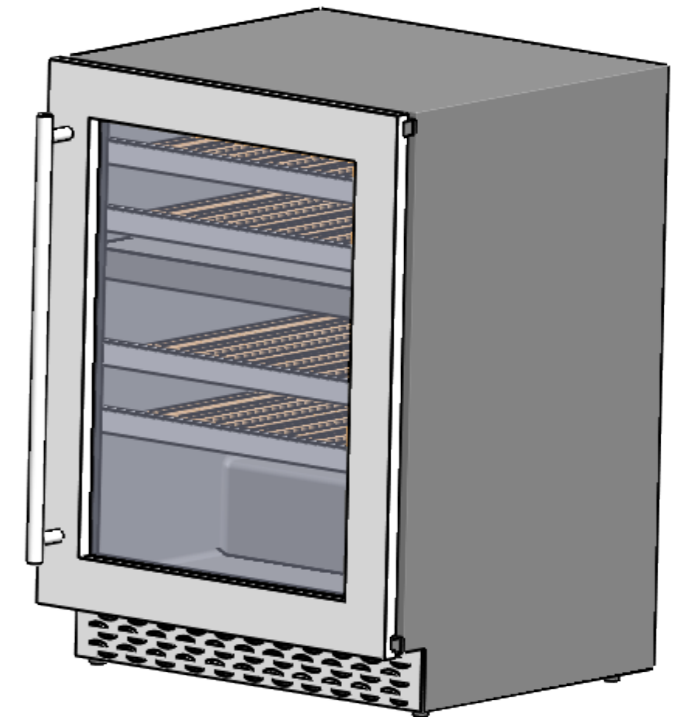

VENTILACIÓN DEL EQUIPO
(NO OBSTRUIR VENTILACIÓN)



PLANTA

CARACTERÍSTICAS	
Volumen	119L
Capacidad	39 botellas.
Ranfo temperaturas	10-20°C (misma temperatura) 5-12°C/12-20°C (temperaturas individuales)
Frecuencia	50Hz
Consumo	1 (12°C) kw/d
Voltaje	220/140V
Ruido	43Db
Refrigerante	R600a
Humedad interior	>70% RH
Sistema de frío	Compresor

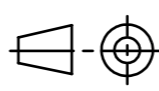
Date	Name	 <small>THE INFORMATION CONTAINED IN THIS DRAWING IS THE SOLE PROPERTY OF CAVANOVA WINE S.L. IN MÁLAGA, SPAIN. ANY REPRODUCTION IN PART OR AS A WHOLE WITHOUT THE WRITTEN PERMISSION OF CAVANOVA WINE S.L. IS PROHIBITED.</small>		
Design:	09/10/2018			Diego
Checked:				Diego
Modified:				Diego
Scale: 1:10	Part name:	Top assembly:	Client: Cavanova	
Unit: mm	CV046DT	CV046T	Material: Acero inoxidable pintado	
Sign: 	Description:		Reference: CV046DT	
	Vinoteca para 46 botellas		Count:	
			Pages: 2 OF 4	

Area recomendada para vinos tintos
Rango temperatura de 12-20°C

Area recomendada para vinos blancos
Rango temperatura de 5-12°C

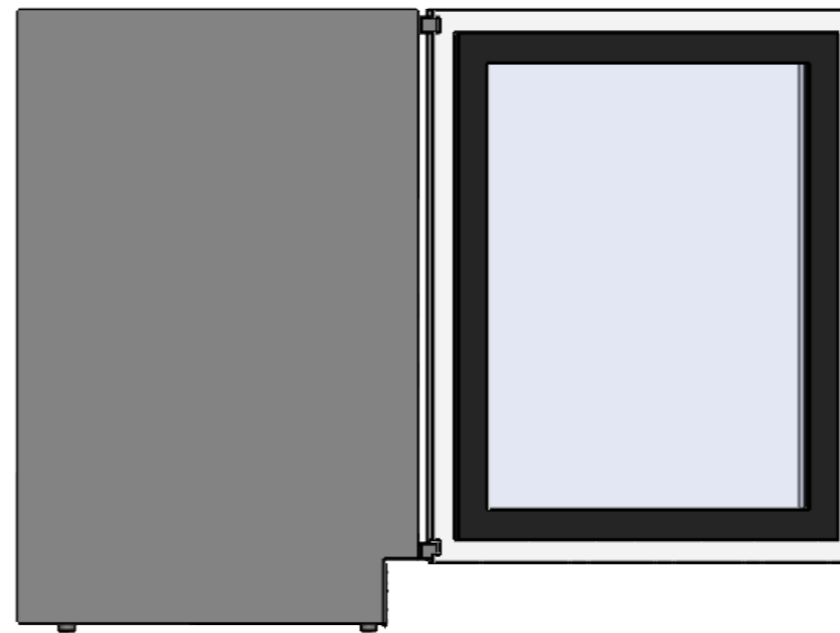
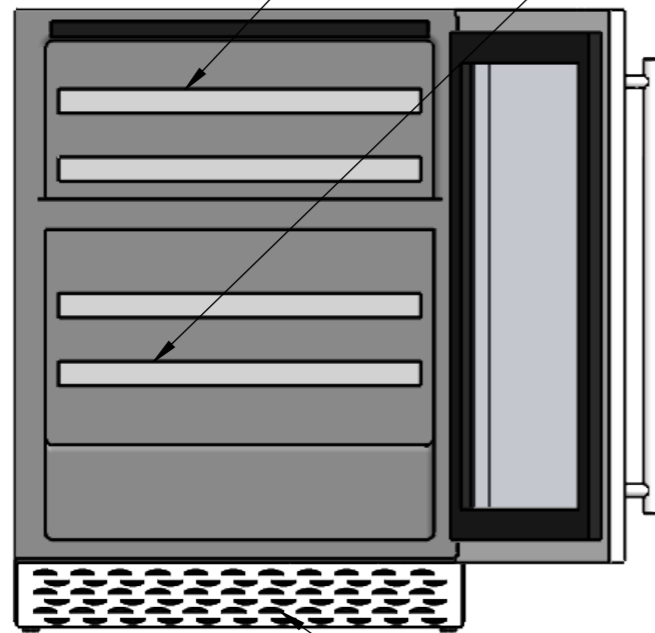

ALZADO

PERFIL

VENTILACIÓN DEL EQUIPO
(NO OBSTRUIR VENTILACIÓN)

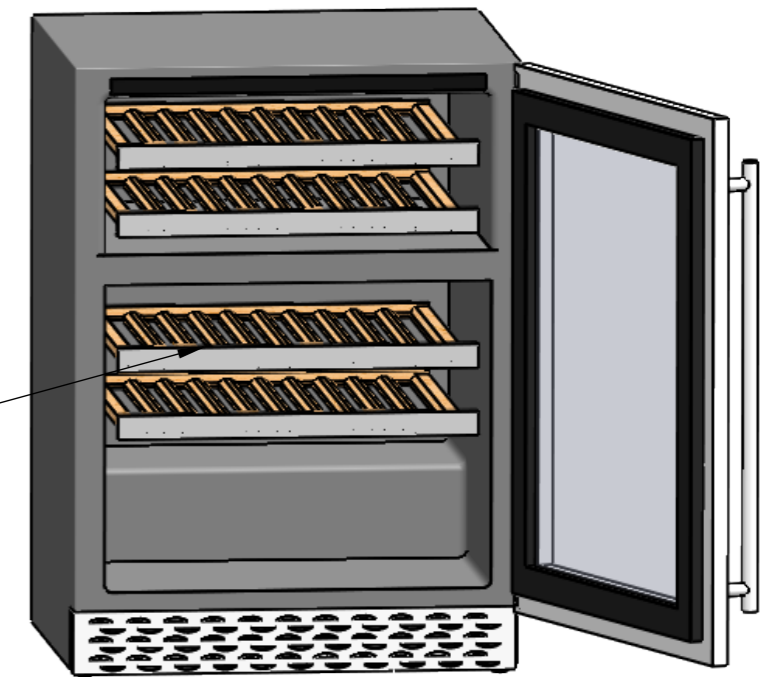

4 baldas de madera

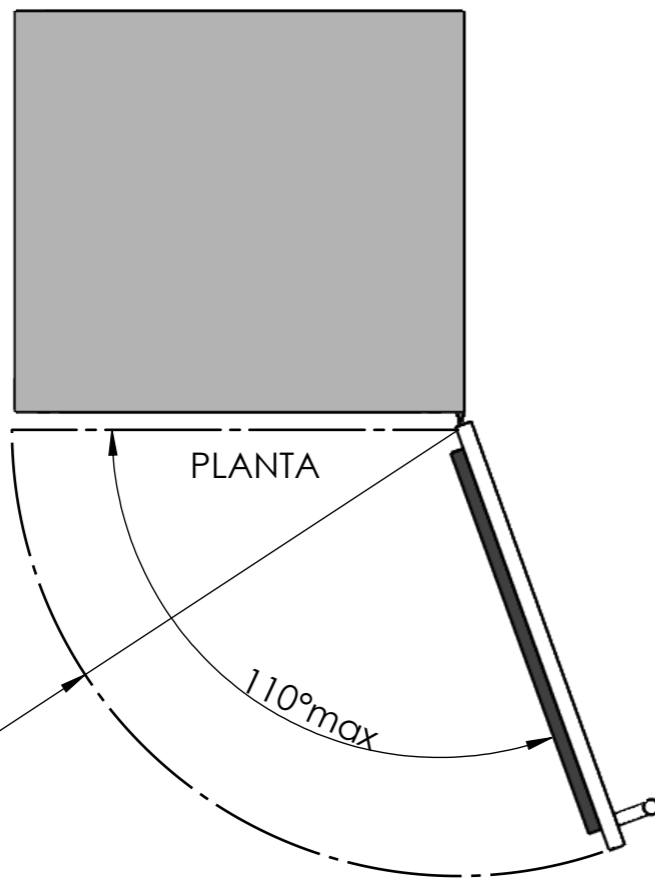

PLANTA

110°max

R590

Sign:

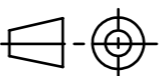
	Date	Name	 <small>THE INFORMATION CONTAINED IN THIS DRAWING IS THE SOLE PROPERTY OF CAVANOVA WINE S.L. IN MÁLAGA, SPAIN. ANY REPRODUCTION IN PART OR AS A WHOLE WITHOUT THE WRITTEN PERMISSION OF CAVANOVA WINE S.L. IS PROHIBITED.</small>	
Design:	09/10/2018	Diego		
Checked:		Diego		
Modified:		Diego		
Scale: 1:10	Part name: CV046DT		Top assembly: CV046DT	Client: Cavanova
Unit: mm				Material: Varios
	Description: Vinoteca 2 temperaturas para 46 botellas			Reference: CV046DT
				Count:
				Pages: 3 OF 4

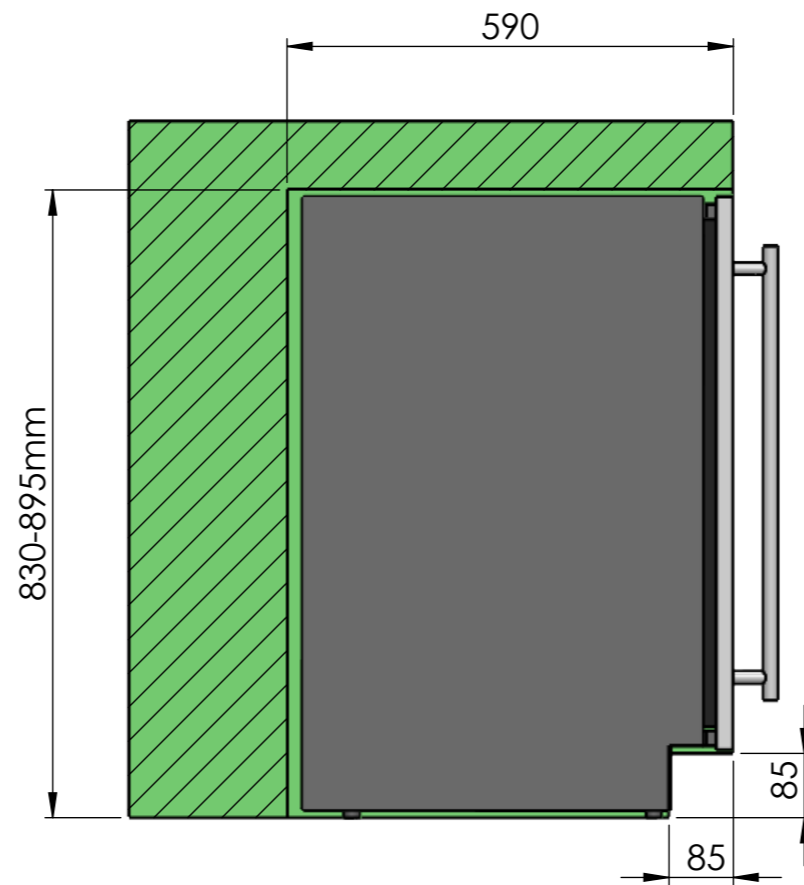
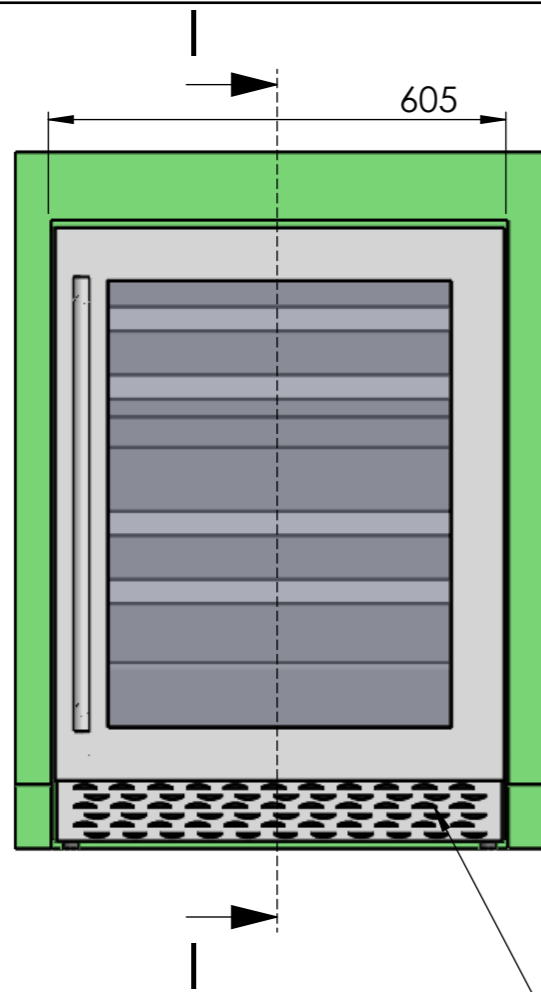

SECCIÓN I-I
ESCALA 1 : 10

Entrada y salida de aire para refrigeración del equipo
(NO OBSTRUIR)

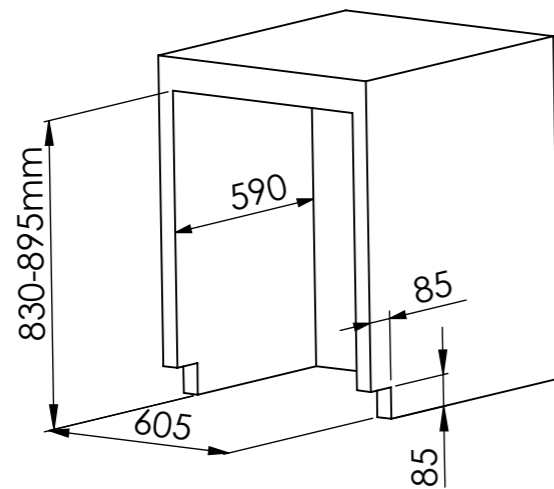

HUECO PARA INTEGRAR NEVERA

DIMENSIONES RECOMENDADAS	
ALTO	830-895mm
ANCHO	605mm
PROFUNDO	590mm

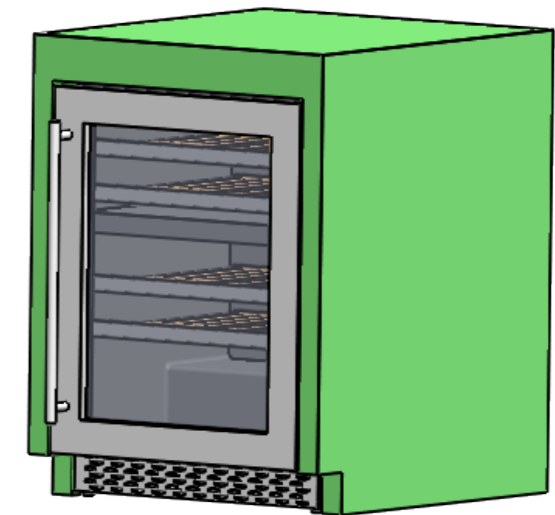

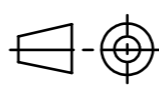
Date	Name	 <small>THE INFORMATION CONTAINED IN THIS DRAWING IS THE SOLE PROPERTY OF CAVANOVA WINE S.L. IN MÁLAGA, SPAIN. ANY REPRODUCTION IN PART OR AS A WHOLE WITHOUT THE WRITTEN PERMISSION OF CAVANOVA WINE S.L. IS PROHIBITED.</small>	
Design:			
Checked:			
Modified:			
Scale: 1:20	Part name:	Top assembly:	Client:
Unit:			Material:
	Description:		Reference:
			Count:
			Pages: 4 OF 4

Sign: